

# MISSION PREP



CHALLENGER CENTER FOR SPACE SCIENCE EDUCATION



# MISSION PREP

## A Teacher's Activity Guide

Another in the Series of  
**Challenger Learning EdVentures**  
from

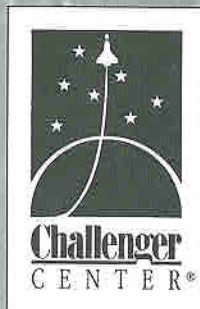

© 2001, Challenger Center for Space Science Education.

No portion of this guide may be reproduced without  
written permission, except for individual classroom use.



# Table of Contents



Dear Educators .....	v
Challenger Center's Pedagogy and National Standards .....	vi
Voyage to Mars .....	vii
Rendezvous With a Comet .....	viii
Encounter Earth .....	ix
Return to the Moon .....	x
Mission Preparation Tips .....	xi
Assembling Your Teams .....	xii
Team Descriptions .....	xiii
Crew Manifests .....	xv
Positions Available .....	xvii
Job Application .....	xix

## ACTIVITIES

<b>Acids and Bases</b> .....	1
How do scientists conduct experiments to classify acids and bases?	
<b>X &amp; Y Coordinates</b> .....	5
How are the X & Y axes used to find a specific location?	
<b>Latitude and Longitude</b> .....	9
How do lines of latitude and longitude help us to locate position?	
<b>Chromatography</b> .....	13
What can the process of chromatography reveal about a substance?	
<b>Pulse and Blood Pressure</b> .....	16
How can scientists monitor human biological systems?	





<b>Electromagnetic Spectrum</b> . . . . .	<b>20</b>
Is all light the same?	
<b>Reading Equipment with Scales</b> . . . . .	<b>24</b>
How can instruments of measure assist us in scientific investigation?	
<b>Average Temperature</b> . . . . .	<b>28</b>
How can scientists use data to determine the average climate of a particular region?	
<b>Mission Patch</b> . . . . .	<b>32</b>
How can a team create a graphic design that represents all of the members and the team mission?	
<b>Press Conference</b> . . . . .	<b>36</b>
How can you express personal ideas and experiences to others?	
<b>Communication</b> . . . . .	<b>39</b>
Why are clear and concise directions important to a mission?	
<b>Mission Survival</b> . . . . .	<b>47</b>
Why is reaching consensus and prioritizing essential to making team decisions?	
<b>Glossary</b> . . . . .	<b>51</b>
<b>Challenger Center Resources</b> . . . . .	<b>53</b>
<b>Acknowledgments</b> . . . . .	<b>56</b>



# Dear Educator

## Dear Classroom Educator,

Envision consoles instead of desks ... computers instead of chalkboards ... and multimedia databases instead of libraries. Textbooks have been replaced with task cards, instructions with procedures. Students become scientists and engineers. Their lessons become missions. Their classroom ... a Challenger Learning Center.

Students are immersed in a realistic Mission Control and Space Station environment: computer consoles, communication headsets, continuous messages on the loud speakers, electronic messages, teammates they can only see on video monitors, emergency sounds and flashing lights, and hands-on activities at science stations.

Challenger Center specifically designed these simulation programs to provide students with an authentic encounter with science and technology. The science is presented in the context of a realistic space exploration. The technology is used as a tool to communicate with teammates and to solve problems and make decisions key to each mission's success.

The simulation creates a cooperative learning atmosphere underscored by teamwork, communication, problem-solving, and decision-making. Embedded throughout the simulations are opportunities for students to apply the skills they have learned in the classroom.

Key to each student's learning experience at a Challenger Learning Center is the preparation that takes place in the classroom in the weeks leading up to a mission. This **Mission Prep** guide contains classroom activities designed specifically to help familiarize students with the skills they will employ to successfully complete their mission.

Regardless of a student's cultural background, economic situation, gender, learning style, or academic level, every Challenger Center simulation provides students with an opportunity to succeed. Every mission is successful! Students leave with a renewed spirit of camaraderie and boosted self-esteem.

Teachers will find that each activity has been correlated to national education standards and is formatted to easily find objectives and key concepts. These activities were designed to provide teachers with as much flexibility as possible so that they can be used in a way that is appropriate for your classroom.

At Challenger Center, we believe exploration is the essence of learning. We also believe that there are no tools, no programs, no techniques that will ever replace the direct intervention of a great teacher in a student's life. By integrating the classroom preparation into the mission simulation, we are confident your students will discover how fun learning can be. Inspiring. Exploring. Learning. It's Our Mission.

Best Regards,  
The Challenger Center Team

# Challenger Center's Educational Pedagogy

Challenger Center's educational pedagogy promotes scientific literacy by encouraging exploration and inquiry and exciting young people about knowledge and learning. Challenger Center believes exploration is the essence of learning. Our goal is to give teachers the tools to create a "learner-centered" environment and to provide materials that are a framework for embedding subject content in a meaningful and motivational context.

Using our interdisciplinary, inquiry-based approach that incorporates national educational standards, Challenger Center strives to:

- Increase student interest in science, mathematics, and technology.
- Give abstract concepts concrete meaning.
- Help students develop realistic processes of cooperation, communication, critical thinking, and problem solving.
- Increase student autonomy and responsibility for their own learning.
- Encourage students to develop positive perspectives about learning.
- Increase student commitment to learning.
- Help students pose questions and find pathways to answers.

Challenger Center programs are designed to reflect academic standards such as the *National Science Education Standards* by the National Research Council and the *Curriculum and Evaluation Standards for School Mathematics* by the National Council of Teachers of Mathematics.

## Activity Matrix for National Science Education Standards, Curriculum & Evaluation Standards for Mathematics, Geography Standards, and Language Arts Standards (Grades 5-8)

	NATIONAL SCIENCE STANDARDS	Unifying Concepts and Processes	Systems, order, and organization	Evidence, models, and explanation	Change, constancy, and measurement	Form and function	Science as Inquiry	Abilities necessary to do scientific inquiry	Understanding about scientific inquiry	Physical Science	Transfer of energy	Life Science	Structures and function in living systems	Regulation and behavior	Populations and ecosystems	Science and Technology	Abilities of technological design	Understanding about science and technology	Science in Personal and Social Perspectives	Science and technology in society	History and Nature of Science	Science as human endeavor	Nature of science	History of Science	GEOGRAPHY STANDARDS	World in Spatial Terms	STANDARDS FOR ENGLISH	Students use spoken or written and visual language	NATIONAL MATHEMATICS	Mathematics as Problem Solving	Mathematics as Communication	Mathematics as Reasoning	Mathematical Connections	Number and Number Relationships	Measurement		
Acids & Bases			♦	♦			♦	♦											♦																		
X & Y Coordinates																														♦		♦					
Latitude and Longitude																										♦											
Chromatography			♦	♦			♦	♦				♦	♦				♦	♦				♦	♦														
Electromagnetic Spectrum			♦	♦			♦	♦		♦							♦	♦		♦		♦	♦														
Reading Equipment with Scales			♦	♦	♦		♦	♦									♦	♦		♦		♦	♦														
Average Temperature			♦	♦			♦	♦									♦	♦		♦		♦	♦														
Pulse and Blood Pressure			♦	♦	♦							♦					♦	♦		♦		♦	♦														
Mission Survival																						♦					♦										
Communication																											♦										
Mission Patch																											♦										
Press Conference																											♦										



# Voyage to Mars

## Mission Overview

In Earth years, it is 2076, and a now routine Voyage to Mars has brought the latest human crew into Martian orbit. Control of the incoming flight has been transferred from Houston's Mission Control to Mars Control at Chryse Station. The crew arriving from Earth on the Mars Transport Vehicle has been specially trained to replace the existing crew of astronauts, which has manned Mars Control for the past two years, and to continue their scientific explorations.

It was 100 years ago when Viking 1 & 2 made the first United States' robotic landings on Mars in the late 1970s, giving humans their first up-close look at the Martian surface.

A renewed interest in Earth's planetary neighbor was spurred by Mars Pathfinder with its July 4, 1997, landing and its small robotic rover named Sojourner. This microwave-sized rover rekindled the human spirit of exploration as it crawled around an ancient flood plain on Mars sniffing rocks and snapping pictures that provided the most detailed look ever at the Red Planet's surface.

The success of Pathfinder and its little hitchhiker set the stage for an armada of robotic spacecraft that over the next three decades paved the way for the first human landings on Mars. The data collected during the early years of the new millennium

by robotic explorations and spacecraft in Martian orbit have directed the human explorations.

Studies of the ancient flood plains and incredible canyons are part of an effort to find out what happened to the water that once flowed across Mars, to find out if the planet once had a more Earth-like environment, and if so, to find out why it changed and if this change could happen on Earth. The crew on the Martian surface has collected and analyzed a great number of geologic and soil samples, as well as data gathered by probes on the Martian moons.

The Mars Control team is charged with the selection of entry and departure trajectories before the landing and subsequent lift-off of the Mars Transport Vehicle can occur.

The crew on the Mars Transport Vehicle is tasked with the launching of probes targeted at the Martian moons. A probe will be launched to Phobos prior to landing, and then another to Deimos before the flight back to Earth.

Both the relief crew and the planet-based crew will be under tight deadlines to gather important data and communicate information to the teams, the spacecraft, and the Mars base. The crews also will gain an appreciation for the "luxuries" of planet Earth—such as air, water and food—as compared to a barren planet such as Mars.

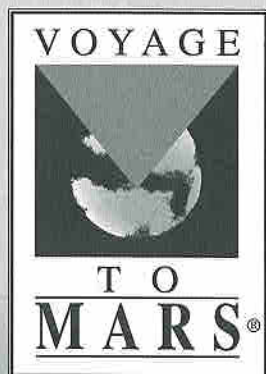

# Rendezvous with a Comet

## Mission Overview

It is the not-too-distant future and teams of scientists are routinely using small, maneuverable space stations to venture out into Earth's "neighborhood" as part of a long-term study of small bodies in the Solar System. Primary targets include comets and asteroids, which scientists believe are the oldest, most primitive bodies in the Solar System and may preserve the earliest record of the material that formed Earth and its planetary neighbors.

During this mission, team members work as scientists and engineers headed to Rendezvous with a Comet as part of this continuing study of our Solar System. These rendezvous missions are critical in helping scientists verify and better understand data collected by earlier small body missions occurring at the start of the new millennium, such as STARDUST and its capture of cometary material from comet Wild-2 in 2004 and the return of that material to Earth in 2006. The actual samples provided by STARDUST established detailed baseline data on comets still used today.

The onboard astronauts, working with their counterparts in Mission Control, are tasked with sending a probe to intercept and collect new data on a well-studied short-period comet before heading on to study the asteroid Ceres, the

largest asteroid, with a diameter of 623 miles (1,003 km).

Comet Encke provides an excellent target because its short period (3.3 years) has allowed it to be observed from Earth at more apparitions (or appearances) than any other comet, including the famous Comet Halley. Encke continues to puzzle scientists because even though it has been in a short-period orbit for thousands of years, the comet continues to have a high level of activity as the Sun's heat boils off its dirty ices into gases and dust. This is the first probe to rendezvous with Encke since 2003 and the fly-by of the comet-chasing CONTOUR spacecraft.

The small, maneuverable space stations used for these rendezvous missions require lots of maintenance and care, providing plenty of challenges for the crews in space and on the ground. Navigating into the correct position for probe launches—not to mention sending a probe through the material surrounding an active comet—also requires concentration and teamwork to successfully collect vital scientific information and complete the mission.

Small bodies in the Solar System are also highly unpredictable objects and have been known to surprise scientists from time to time, so crew members will also need to be on their toes and ready to make quick decisions.

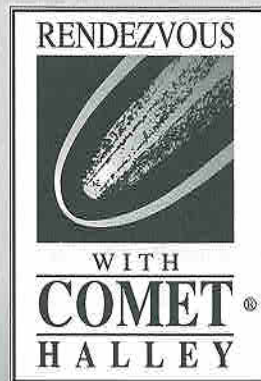

# Encounter Earth

## Mission Overview

**E**nvironmental scientists collect data from all over the Earth's surface. This raw data is analyzed to obtain a global view of Earth's environment on a daily, seasonal, annual, and long-term basis. A common data collection technique is the use of Earth-based probes. Probes are placed at many different locations on Earth's surface to measure important environmental conditions such as ocean temperatures, currents, and vegetation, as well as land vegetation, troposphere (lower atmosphere) temperatures, and ground moisture.

The information collected by these probes is transmitted to a low-Earth orbiting (LEO) satellite. The LEO satellite then transmits the probe information to ground-based stations such as the Jet Propulsion Laboratory in Pasadena, California, or to a Geosynchronous Orbiting (GEO) satellite, which in turn transmits the information to the ground-based stations.

In the summer of the year 2137, the LEO satellite collecting probe data has malfunctioned and must be replaced. The elite ERS-I Emergency Response Squad composed of 8 teams trained in satellite design and environmental survey has been called in. One half of the ERS-I crew has been stationed on a LEO Spacelab and is working diligently to construct a new satellite to deploy into orbit for data collection.

Since the Earth-based probes are designed to transmit data on a regular basis to the LEO satellite, they contain very little data storage capacity. While the ERS-I Satellite Team is constructing the new satellite, the data collection teams (*GEosphere*, *HYDRosphere*, *ATMosphere*, *BIOsphere*, and *ECOsphere*) must collect and transmit data from areas near the probes to Mission Control.

The other half of the ERS-I crew has been stationed on Earth in the Ops Center of Mission Control. These team members analyze the probe data and compare it to historical data in order to correlate relationships. Additionally, Mission Control, along with their Spacelab teammates, examines sensor data for environmental conditions that might pose a threat to planet Earth and its inhabitants.

Transmission of data and information occurs with the aid of two teams, COM (*COMmunication*) and DAX (*Data Acquisition and EXamination*). DAX has the additional duty of conducting research to aid the investigation of the data collection teams.

Once the LEO satellite is constructed and deployed, it can resume the job of data collection and transmission. The ERS-I Emergency Response Squad can return to Earth with a greater knowledge about their home planet and a sense of accomplishment, having completed a successful mission.

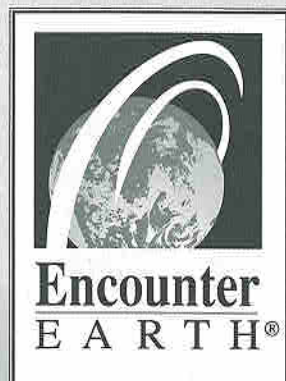

# Return to the Moon

## Mission Overview

The new millennium is still young, but humans are preparing to **Return to the Moon**, spurred on by the suggestion of frozen water (“water ice”) on the lunar surface by Lunar Prospector in 1998. Composed of hydrogen and oxygen—the elements that make up water—the lunar ice provides a core resource for long-term human presence on the lunar surface.

Lunar Prospector was followed by a series of successful robotic missions designed to prove the concept that the water ice could be harvested. Once collected, the water ice can be turned into drinking water, oxygen for life support of a lunar base, nutrients as the basis for agriculture, components needed for rocket fuel, or when combined with lunar soil, the basics for construction materials. Not only did those robotic missions successfully prove the concept, but since then additional robotic staging missions have landed and begun manufacturing these essential resources.

As part of the **Return to the Moon** mission, this crew of astronauts will—for the first time since the Apollo 17 mission in 1972—land on the surface of the Moon. This time the astronauts are there to establish a permanent base with the core goals of:

1. establishing an observation program to study the Earth and other Solar System bodies without the interference of the Earth’s atmosphere,
2. testing the feasibility of a self-sustaining, off-planet settlement, and
3. serving as a staging area for additional human exploration of our Solar System.

The **Return to the Moon** mission begins with the spacecraft in Earth orbit and the Mission Control team monitoring the crew’s status. The crew aboard the spacecraft will leave Earth orbit and travel to the Moon using the latest in transport technology to reduce the travel time. In addition to verifying the best site for the establishment of the lunar base, during the course of the mission the crew will build and launch a probe to the lunar surface, recover a probe that is stranded in space, and repair the damaged probe.

Some information has been previously obtained from the potential lunar base sites. A detailed study has determined that the base site must contain soils, metals, and potentially useful resources such as helium-3. Rock and soil samples, soil composition, and seismic information have been gathered by previous missions from a portion of the potential sites. Experiments on soil and rock samples from other possible sites must be performed in order to determine the best site for the lunar base.

The crew will navigate their spacecraft to the Moon and plot an acceptable orbit. Together the crew will place their spaceship into lunar orbit and make the important decision of the location of the first permanent lunar base. To gather the data needed to analyze potential lunar base sites, the crew will have to function as a team and utilize their best communication and analytical skills.

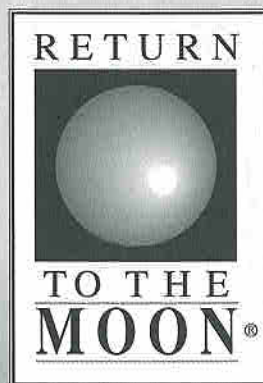

# Mission Preparation Tips



## Several weeks before the mission

---

- Find out which mission your class will fly. Get the activity guide for that mission and complete the activities to get your students mission savvy.
- Go through this guide and do these activities to help your class brush-up on skills needed to fly any Challenger Learning Center mission.

## A few weeks before the mission:

---

- Complete the Crew Manifest on page xv and bring two copies of the manifest to the Challenger Learning Center on the day of your flight.
- As you fill out your manifest, assign two students to each team, one at Mission Control and one at the Spacecraft. Put two more students at Navigation and Probe, then fill in the other positions as needed.
- Be sure to use the correct Positions Available form and the correct Crew Manifest for your mission. There is one common form for *Voyage to Mars*, *Return to the Moon*, and *Rendezvous with a Comet*. *Encounter Earth* has its own unique forms.
- Review the mission overview with your students.

## Day of the mission:

---

- Bring Manifest.
- Bring Mission Patch.



# Assembling Your Teams

In preparation to fly a mission at a Challenger Learning Center, students “apply” for available positions and are assigned by their teacher to their roles. Challenger Center believes the classroom teacher is best suited to make the student assignments to teams which best match their abilities and interests. To ensure a positive learning experience for every student, please give careful consideration as you assign students to the teams.

To help you make those assignments, use the “Job Application” in this book to determine the students’ personal preferences. Then use other information at your disposal, such as skill level or learning styles, to provide a good match of each student’s abilities with the position requirements.

The Team Descriptions on the next page outline the roles and responsibilities of each position to help teachers make student assignments. Challenger Center has characterized additional information about skill requirements and learning styles for each description to use as appropriate in making your student assignments.

In addition to providing an authentic setting in which to apply skills learned in the classroom, every Challenger Learning Center also provides students with a dynamic, multi-sensory environment. Research shows that people use all of their senses to learn. That same research shows that while most people use a combination of particular sensory styles to process information, one dominant style usually dictates their preferred method of learning: kinesthetic, visual, tactile, and/or auditory. Kinesthetic learners learn best by hands-on physical involvement. Visual learners may prefer reading, taking notes, and making lists. Tactile learners may work best at their own pace in a comfortable secure environment, while auditory learners may prefer group discussions and listening to lectures.

Each mission requires the cooperative effort of eight teams. Teams will do a “crew swap” so that each team will experience Mission Control as well as the Spacecraft during the course of the mission.

## **Have students:**

1. Review the positions available for their mission as a class.
2. Complete a Job Application.
3. Submit completed applications to their teacher for position assignments.

## **If you would like more information about learning styles, Challenger Center suggests:**

R. & Sisco, B.R. (1990). Individualizing instruction. San Francisco: Jossey-Bass. James, W.B. & Blank, W.E. (1991). A comparison of perceptual learning styles of adult high school graduates and nongraduates. *Adult Basic Education*, 1(2), 98-106. Smith, D.K., & Holiday, P.J. (1987). Learning styles and academic achievement. *Focus on Learning Problems in Mathematics*. Stronck, D.R. (1980). The educational implications of human individuality. *American Biology Teacher*. Wood, J.W. (1984). *Adapting instruction for the mainstream: A sequential approach to teaching*. Columbus, OH: Charles E. Merrill.

# Team Descriptions



## Voyage to Mars, Return to the Moon, Rendezvous with a Comet

**COMMUNICATIONS TEAM (COM):** As a member of the Communications Team the students will be responsible for all verbal communication between Mission Control and the Space Station.

**Skills:** Proficiency in reading and oral communications, ability to work in high stress situations, ability to prioritize

**Learning Style:** Favor an auditory learning style

**MEDICAL TEAM (MED):** As a member of the Medical Team the students will monitor and analyze auditory and visual response time, respiration rate, skin temperature, and heart rate of Space Station personnel.

**Skills:** Data entry skills, a strong interest in biological sciences, math skills (simple averaging)

**Learning Style:** Favor a visual learning style

**ISOLATION TEAM (ISO):** As a member of the Isolation Team the students will be responsible for conducting research and data analysis of radioactivity, meteoroids, and hazardous materials.

**Skill:** Strong eye hand coordination, use of measurement devices (balance), reasoning, patience

**Learning Style:** Favor a kinesthetic learning style

**LIFE SUPPORT TEAM (LS):** As a member of the Life Support Team the student will perform water supply tests, analyze data from pH tests, and read solar panels.

**Skills:** Strong problem solving skills, interest in environmental and biological sciences

**Learning Style:** Favor a visual or kinesthetic learning style

**DATA TEAM (DATA):** As a member of the Data Team the students will be responsible for data entry, synthesizing and summarizing data from the Research Program, and the video link between Mission Control and the Space Station.

**Skills:** Proficiency in reading and oral communications, ability to work in high stress situations

**Learning Style:** Favor a visual or auditory learning style

**NAVIGATION TEAM (NAV):** As a member of the Navigation Team the students will send and receive messages, calculate trajectories, and analyze and determine angles for launch coordinates.

**Skills:** Data entry skills, strong math skills, interest in astronomy

**Learning Style:** Favor a visual or auditory learning style

**PROBE TEAM (PROBE):** As a member of the Probe Team the students will be responsible for assembly, deployment, and monitoring of a space probe.

**Skills:** Strong mechanical skills, proficiency in math and reading, analytical problem solving, deduction skills, self motivation

**Learning Style:** Favor a kinesthetic learning style

**REMOTE TEAM (REM):** As a member of the Remote Team the students will operate the robotic arm and collect and analyze mass, volume and chromatography data.

**Skills:** Strong mechanical and observation skills, proficiency in reading

**Learning Style:** Favor a kinesthetic or visual learning style

## Encounter Earth

---

★ **Communications Team (COM):** Team members will be responsible for all verbal messages transferred between Mission Control and the Spacelab.

**Skills:** Reading, oral communication, ability to prioritize

**Learning Style:** Favor an auditory learning style

★ **Biosphere Team (BIO):** These team members will determine whether vegetation is directly related to the ground moisture and/or temperature. During emergencies, team members may simulate the amount of light that passes through volcanic ash and determine the effect of an oil spill in the ocean.

**Skills:** Computer keyboard operation, math skills (measurement, averaging, and estimation)

**Learning Style:** Favor a visual or kinesthetic learning style

★ **Ecosphere Team (ECO):** Team members will determine whether population density is directly related to lights observed at night. During emergencies, team members will determine the effect of CO<sub>2</sub> on plants and use a microscope to determine the potability of water.

**Skills:** Computer keyboarding operation, math, observation, and mechanical skills

**Learning Style:** Favor a visual or kinesthetic learning style

★ **Hydrosphere Team (HYDRO):** Team members will determine whether ocean temperatures and/or currents are directly related to ocean vegetation. During emergencies, team members will perform pH tests on the water supply and test water for total dissolved solids and chlorine.

**Skills:** Computer keyboard operation, math, measurement, and observation skills

**Learning Style:** Favor a visual or kinesthetic learning style

★ **Data Acquisition and Examination Team (DAX):** Team members will be responsible for data that must travel between Mission Control and the Spacelab. They will also be the primary researchers for the Spacelab and Mission Control crews.

**Skills:** Computer keyboard operation, math, measurement, and observation skills

**Learning Style:** Favor a visual or auditory learning style

★ **Atmosphere Team (ATM):** Team members will determine whether rainfall and/or temperature are directly related to cloud cover. During emergencies, team members will determine the amount of dissolved oxygen in the water and do qualitative analysis of gas using a spectroscope.

**Skills:** Computer keyboard operation, math, measurement, and observation skills

**Learning Style:** Favor a visual learning style.

★ **Satellite Team (SAT):** Team members will determine the correct communication frequencies for Earth probes, satellites, and Earth laboratories. They will build and deploy a new low-Earth orbiting satellite to replace a non-functioning satellite.

**Skills:** Computer keyboard operation, math, mechanical, reading, and deductive reasoning skills

**Learning Style:** Favor a kinesthetic learning style

★ **Geosphere Team (GEO):** Team members will determine whether ocean temperatures and/or currents are directly related to sea level. During emergencies, team members will use robots to collect soil samples to be tested for pH and determine the effect of flooding on different land areas.

**Skills:** Computer keyboard operation, math, measurement, and observation skills

**Learning Style:** Favor a visual learning style



# Crew Manifest

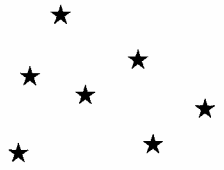

Mission _____		Date _____			
School _____		Teacher _____			
Teams		Mission Control Crew		Space Station Crew	
<b>COM</b> (Communications) 2 Members 1@ Mission Control 1@ Space Station		_____		_____	
<b>DATA</b> 2 Members 1@ Mission Control 1@ Space Station		_____		_____	
<b>NAV</b> (Navigation) 2-4 Members (Minimum 2) 1@ Mission Control 1@ Space Station		_____ _____		_____ _____	
<b>MED</b> (Medical) 2-4 Members (Minimum 2) 1@ Mission Control 1@ Space Station		_____ _____		_____ _____	
<b>PROBE</b> 2-4 Members (Minimum 2) 1@ Mission Control 1@ Space Station		_____ _____		_____ _____	
<b>REM</b> (Remote) 2-6 Members (Minimum 2) 1@ Mission Control 1@ Space Station		_____ _____ _____		_____ _____ _____	
<b>LS</b> (Life Support) 2-6 Members (Minimum 2) 1@ Mission Control 1@ Space Station		_____ _____ _____		_____ _____ _____	
<b>ISO</b> (Isolation) 2-6 Members (Minimum 2) 1@ Mission Control 1@ Space Station		_____ _____ _____		_____ _____ _____	

NOTE: This page is for use with the Return to the Moon, Voyage to Mars, and Rendezvous with a Comet missions. Crew members will begin at their assigned locations and then switch at the halfway point.

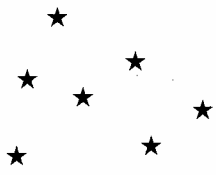

# Encounter Earth Crew Manifest

Mission _____	Date _____
School _____	Teacher _____

Teams	Mission Control Crew	Spacelab Crew
<b>COM</b> (Communications) 2 Members 1@ Mission Control 1@ Spacelab	_____	_____
<b>DAX</b> (Data) 2 Members 1@ Mission Control 1@ Spacelab	_____	_____
<b>SAT</b> (Satellite) 2-4 Members (Minimum 2) 1@ Mission Control 1@ Spacelab	_____ _____	_____ _____
<b>HYDRO</b> (Hydrosphere) 2-4 Members (Minimum 2) 1@ Mission Control 1@ Spacelab	_____ _____	_____ _____
<b>GEO</b> (Geosphere) 2-6 Members (Minimum 2) 1@ Mission Control 1@ Spacelab	_____ _____	_____ _____
<b>BIO</b> (Biosphere) 2-6 Members (Minimum 2) 1@ Mission Control 1@ Spacelab	_____ _____ _____	_____ _____ _____
<b>ATM</b> (Atmosphere) 2-6 Members (Minimum 2) 1@ Mission Control 1@ Spacelab	_____ _____ _____	_____ _____ _____
<b>ECO</b> (Ecosphere) 2-6 Members (Minimum 2) 1@ Mission Control 1@ Spacelab	_____ _____ _____	_____ _____ _____

NOTE: This page is for use with the Encounter Earth mission. Crew members will begin at their assigned locations and then switch at the halfway point.

# Positions Available

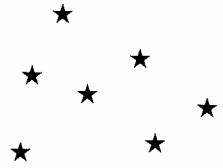

## Voyage to Mars, Return to the Moon, Rendezvous with a Comet

**Title: COMMUNICATIONS OFFICER**

**Description:** As a member of the Communications Team, the applicant will be responsible for all communications between Mission Control and the Space Station.

**Requirements:** Proficiency in reading and oral communications, ability to work in high stress situations.

**Salary:** Based on level of education.

**Title: MEDICAL TECHNICIAN**

**Description:** As a member of the Medical Team, the applicant will monitor and analyze response time, respiration rate, skin temperature, and heart rate of Space Station personnel.

**Requirements:** Data entry skills, a strong interest in biological sciences.

**Salary:** Based on level of education.

**Title: ISOLATION SPECIALIST**

**Description:** As a member of the Isolation Team, the applicant will be responsible for conducting research and data analysis of radioactivity, meteoroids, and hazardous materials.

**Requirements:** Strong mechanical skills, Proficiency in math, excellent eye-hand coordination.

**Salary:** Based on level of education.

**Title: LIFE SUPPORT SCIENTIST**

**Description:** As a member of the Life Support Team, the applicant will perform tests and analyze data from pH, water, and oxygen tests as well as experiment with solar panels.

**Requirements:** Strong problem solving skills, interest in environmental and biological sciences.

**Salary:** Based on level of education.

**Title: DATA OFFICER**

**Description:** As a member of the Data Team, the applicant will be responsible for the data and video link between Mission Control and the Space Station.

**Requirements:** Proficiency in reading and oral communications, ability to work in high stress situations.

**Salary:** Based on level of education.

**Title: NAVIGATOR**

**Description:** As a member of the Navigation Team, the applicant will send and receive messages and analyze and determine angles for launch coordinates.

**Requirements:** Data entry skills, strong math skills, interest in astronomy.

**Salary:** Based on level of education.

**Title: SPACE PROBE TECHNICIAN**

**Description:** As a member of the Probe Team, the applicant will be responsible for assembly, deployment, and monitoring of a space probe.

**Requirements:** Strong mechanical skills, proficiency in math and reading. Applicant must be self-motivated.

**Salary:** Based on level of education.

**Title: ROBOTIC SCIENTIST**

**Description:** As a member of the Remote Team, the applicant will operate the robotic arm and collect and analyze mass, volume, and chromatography data.

**Requirements:** Strong mechanical and observational skills, proficiency in math.

**Salary:** Based on level of education.



## Encounter Earth

---

### Positions Available

**Title: COMMUNICATIONS OFFICER**

**Description:** As a member of the Communications Team, the applicant will be responsible for all communications between Mission Control and the spacelab.

**Requirements:** Proficiency in reading and oral communications, ability to work in high stress situations.

**Salary:** Based on level of education.

**Title: DATA OFFICER**

**Description:** As a member of the Data Acquisition and Examination Team, the applicant will be responsible for the data and video link between Mission Control and the spacelab.

**Requirements:** Proficiency in reading and oral communications, ability to work in high stress situations.

**Salary:** Based on level of education.

**Title: BIOLOGICAL TECHNICIAN**

**Description:** As a member of the Biosphere Team, the applicant will conduct research on vegetation, including research on the effects of volcanoes and oil spills on the biosphere.

**Requirements:** Data entry, proficiency in math and measurement.

**Salary:** Based on level of education.

**Title: ECOSPHERE SPECIALIST**

**Description:** As a member of the Ecosphere Team, the applicant will study population density and the effects of carbon dioxide on the ecosystem.

**Requirements:** Data entry, proficiency in math, strong observational and mechanical skills.

**Salary:** Based on level of education.

**Title: OCEANOGRAPHER**

**Description:** As a member of the Hydrosphere Team, the applicant will study ocean currents, temperatures, ocean vegetation, and test for pollutants.

**Requirements:** Data entry, proficiency in math, strong observational and mechanical skills.

**Salary:** Based on level of education.

**Title: ATMOSPHERIC SCIENTIST**

**Description:** As a member of the Atmosphere Team, the applicant will study rainfall, temperatures, and cloud coverage.

**Requirements:** Data entry, proficiency in math, strong observational and mechanical skills.

**Salary:** Based on level of education.

**Title: SATELLITE SPECIALIST**

**Description:** As a member of the Satellite Team, the applicant will build and deploy a new satellite and repair a non-functioning satellite.

**Requirements:** Strong mechanical skills, proficiency in math and reading. Applicant must be self-motivated.

**Salary:** Based on level of education.

**Title: HYDROLOGIST**

**Description:** As a member of the Geosphere Team, the applicant will monitor ocean currents, temperatures, and sea level. Hydrologists will also use a robot to collect soil samples and test for pH.

**Requirements:** Data entry, proficiency in math, strong observational and mechanical skills.

**Salary:** Based on level of education.

# Job Application

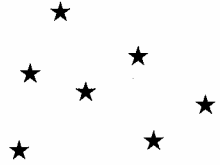

Please review all of the available positions and list your top three choices.

1st Choice \_\_\_\_\_

2nd Choice \_\_\_\_\_

3rd Choice \_\_\_\_\_

## Personal Data

Name: \_\_\_\_\_ Date: \_\_\_\_\_

School: \_\_\_\_\_ Grade: \_\_\_\_\_

Teacher's Name: \_\_\_\_\_

## Relevant Skills and Experience

What makes you best qualified for this position?

---

---

What experiences and skills make you the best candidate for this position?

---

---

List membership in any organizations or civic clubs. (Boy Scouts, Girl Scouts, 4-H, sports teams, etc.)

---

---

List any honors, awards, publications, or personal achievements. (Honor roll, School paper, etc.)

---

---

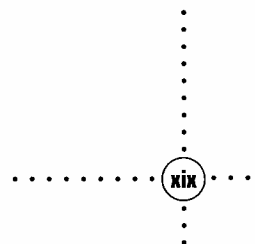



# Acids and Bases

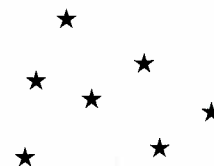

## Background

Scientists use many skills to assist them in their research. Among other things, they need to be able to conduct tests and analyze and classify the data. For example, scientists use the pH scale to identify and classify compounds. The pH scale is a measure of how acidic or basic a sample is.

Acids are nonmetallic chemical compounds that react with some metals to produce hydrogen gas. They have a pH less than 7. An acid will neutralize a base. Bases are metallic chemical compounds that react with water and have a pH greater than 7. A base will neutralize an acid. A substance that is neither an acid nor a base is considered neutral, and has a pH of 7. Water is an example of a neutral substance.

An indicator is used to test a solution for its pH. It may be in the form of a liquid or paper that has been soaked in an indicator liquid. For example, one easily prepared indicator is the Cabbage Juice Indicator.

## Skills

- Conducting experiments
- Reading scales
- Interpreting data
- Classifying compounds

## Objective

Students will:

- Analyze everyday materials to determine whether they are acids, bases, or neutral.

## Overview

In this activity, students will test common solutions by using the pH scale. They will interpret this data and classify the solutions as acids, bases, or neutral.

## Key Question

How do scientists conduct experiments to classify acids and bases?

## Key Concepts

- Interpreting the pH scale
- Classifying acids and bases

## Materials & Preparation

Each of the following solutions: water, bleach, ammonia, vinegar, milk, lemon juice, tomato juice, tea, and liquid soap

- 9 Small plastic cups (20 ml) per group
- 2 Eyedroppers per group
- 2 Large plastic cups (250 ml) per group
- 9 Test tubes per group
- 1 Pair of safety goggles per student
- 1 Apron per student
- 1 head of red cabbage
- 1 Graduated cylinder
- Water

1. Gather materials and assign students to cooperative groups.
2. Prepare the red cabbage indicator: Cut a red cabbage into eight parts. Place cabbage in a non-aluminum pan, cover with water, and boil for 10-15 minutes. (You may wish to use bottled water to ensure neutral pH.)
3. Pour the pan contents through a strainer and discard the cabbage leaves.
4. Cool the juice and store covered in the refrigerator. Freeze the juice in ice cube trays for extended use.
5. Prepare the bleach, ammonia, soap, and vinegar solutions by mixing 1 teaspoon of each liquid with 250 ml of water.
6. Have students look at the list of household products on the chart below. For each solution, have students predict and record if they think it is an acid, base, or neutral.
7. Label the small cups 1-9.
8. Label one large cup *water* and the other *indicator*.
9. Fill the nine small cups half full of each solution.
10. Fill one large cup half full of water.

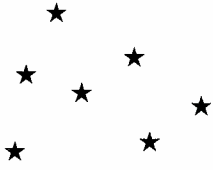

11. Fill one large cup half full of the cabbage juice indicator.
12. Label the test tubes 1-9.
13. Students will use an eyedropper to put 10 drops of indicator into the test tube labeled 1. Place this eyedropper back into the cup of indicator.
14. Students will use the other eyedropper to put 10 drops of solution "1" into the test tube labeled 1.
15. Students will gently shake the test tube to mix the solutions.
16. Students will observe the color and record their observations on the chart below, indicating if the solution is an acid, base, or neutral.
17. Students will clean their solution eyedropper in the water cup and repeat steps 13-16 for each of the solutions.
18. Afterwards, have students clean up test tubes and area.
19. Discuss the results.

**Management**

This activity will take one class period. Be sure to follow all safety rules for working with chemicals.

**Reflection & Discussion**

1. What types of solutions tended to be acidic? What characteristics do they have in common?
2. What types of solutions tended to be basic?

3. What types of solutions tended to be neutral?
4. Were you surprised by any of your findings? If so, how?
5. Hypothesize what other liquids you would expect to be bases, acids, and neutral.
6. What other ways are there to test for acids and bases?
7. Why is it important to know if items are acids or bases?

**Transfer & Extension**

1. Research acid rain.
2. Collect water samples from local water sources to test for pH.
3. Make paper indicators by cutting white blotting paper into strips and soaking the strips in the red cabbage indicator.
4. Use commercially sold synthetic indicators to compare and contrast test results.
5. Experiment to find other plants, fruits, or vegetables that can be used as indicators for an acid, base, or neutral substance.
6. Discuss the role of maintaining pH in swimming pools and salt water aquariums.



# Acids and Bases

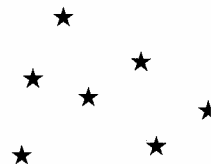

## Student Procedures

1. Look at the list of household products on the chart below. For each solution, record your prediction of whether you think it is an acid, base, or neutral.
2. Use an eyedropper to put 10 drops of indicator into the test tube labeled 1. Place this eyedropper back into the cup of indicator.
3. Use another eyedropper to put 10 drops of solution "1" (lemon juice) into the test tube labeled 1.
4. Gently swirl the test tube to mix the solutions.
5. Observe the color and record your observations on the chart below. Indicate whether the solution is an acid, base, or neutral. The chart lists which colors correspond to an acid, base, or neutral.
6. Clean your solution eyedropper in the water cup and repeat steps 2-5 for each of the solutions.
7. Test your own ideas for numbers 10 and 11.

Data Log for Classification of Solutions			
Solution Name	Prediction	Color	Acid, Base, or Neutral
1. lemon juice			
2. bleach			
3. water			
4. tomato juice			
5. milk			
6. ammonia			
7. tea			
8. vinegar			
9. soap			
10.			
11.			

**indicator + acid = pink**

**indicator + base = green**

**indicator + neutral = purple**

STUDENT WORKSHEET

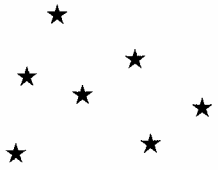

# X & Y Coordinates

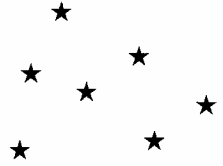

## Background

One piece of information that is essential to us on a daily basis is our location. We may not realize how often we use this type of information, but a little reflection on your conversations and actions over the past 24 hours will reveal a great dependency on being able to accurately state your location. For example, if you speak to a friend on the phone, he or she may ask from where you are calling. This can be as simple as saying, "I'm at Susan's house now, but I'm leaving for home in half an hour." Or you might say, "I am at 334 West 3rd Street in Hometown, Iowa, USA." To be more explicit, you might add, "In the Western Hemisphere of planet Earth, the third planet from a star called the Sun, in the Milky Way Galaxy."

Another way to specify a location is by using a coordinate system. Probably the most-used system is the rectangular, or Cartesian coordinate system. In this system, a grid divides a surface into four quadrants. (See image below.) Locations are given by stating a pair of numbers

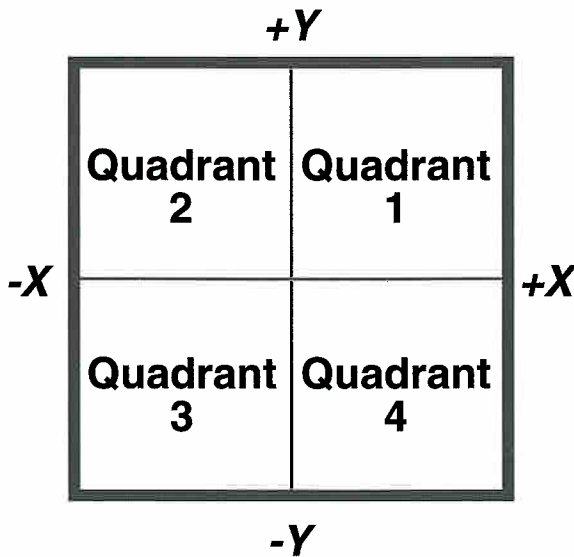

or coordinates. The first number represents a horizontal value, X. This value can be either positive or negative. The second number represents a vertical value, Y, and it too can be either positive or negative. By finding where the horizontal and vertical values intersect, you can determine any location on the grid.

## Skills

- Determining coordinates and intersections
- Reading graphs
- Interpreting data
- Identifying integers and non-integer rational numbers

## Objective

Students will:

- Identify and plot points using an X & Y coordinate grid.

## Overview

In this activity students will use an X & Y coordinate system to locate missing spacecraft on a coordinate grid sheet.

## Key Question

How are the X & Y axes used to find a specific location?

## Key Concepts

- Precise locations can be specified using an X-Y coordinate grid.
- The X axis is the horizontal axis; the Y axis is the vertical axis.
- Locations on a grid are found by calling out a pair of coordinates.

## Materials & Preparation

- 1 Grid Sheet per student
- Pencils
- Paper
- A book or other object to serve as a shield

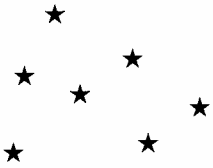

1. Make copies of the grid sheets.
2. Divide students into teams of two.
3. Discuss coordinate systems with the students.
4. Draw a grid on the chalkboard like the diagram above. Draw points and practice identifying points with students. For example (X1, Y2) means finding where the X1 line and Y2 line intersect.
5. Before the class period ends, conclude the lesson with Reflection & Discussion questions.

**Management**

This activity can be completed in one class period.

**Reflection & Discussion**

1. In a coordinate pair, which number represents the X coordinate? Y coordinate?
2. Look at each quadrant. Which quadrants have positive X values? Negative Y values? Positive X, positive Y? Negative X, positive Y?

3. How would locating the spacecraft on the paper be different if you didn't have a coordinate system?
4. Can you think of a situation when the X-Y coordinate system might not be easy to use?
5. Can you think of any real-life examples of coordinate systems?

**Transfer & Extension**

1. Reduce the size of the spacecraft on the grid. How does this affect the time it takes to locate all of the spacecraft? What happens if you increase the grid size?
2. Research several different coordinate systems, specifically those used in astronomical research. Give a report on right ascension and declination as it applies to positions of astronomical objects.
3. Design a system to locate missing spacecraft that would make use of a three-dimensional field. This would require a Z-axis.

# X & Y Coordinates

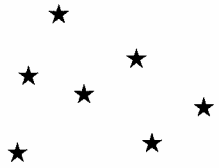

## Student Procedures

1. This activity is done in pairs. Sit on the opposite side of a table or desk from your partner.
2. Place a book or other shield device in the center of the desk. Make sure you cannot see your partner's grid.
3. Draw a spacecraft in each of the 4 quadrants. Your partner will do likewise. *The spacecraft must be the size of 4 squares on the grid.* The object of the game is to be the first person to find all of the missing spacecraft.
4. Decide which of you will go first. (Flip a coin or choose some other method.)
5. Whoever goes first will call out two numbers (the X and Y coordinates), representing a point on the partner's grid. For the sake of example, pretend that your partner is going first.
6. Locate the coordinates on your grid. If this point corresponds to the location of any part of a spacecraft, tell your partner that he or she has found a spacecraft. Your partner now has another turn to find another spacecraft. If at any time your partner's coordinate does not correspond to the location of a spacecraft, it is your turn to find their spacecraft.
7. Keep track of the coordinates you have called so as not to repeat a coordinate pair.
8. When all spacecraft are located, try again with new grid sheets.

STUDENT WORKSHEET

Grid Sheet

$(-x, +y)$

$+Y$

$(+x, +y)$

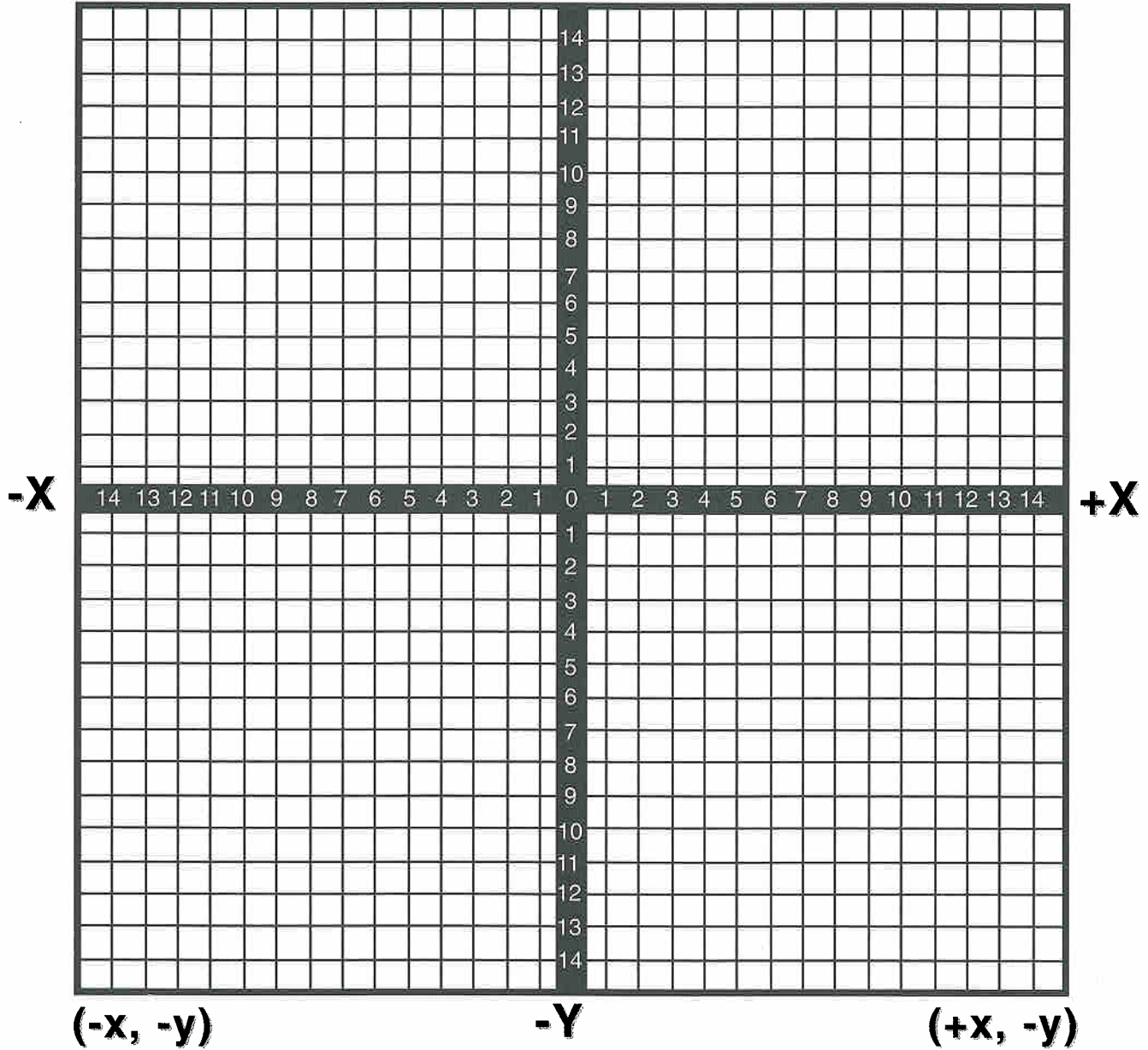

# Latitude and Longitude

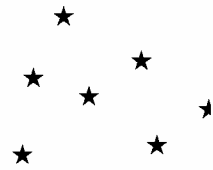

## Background

The importance of identifying a specific location on Earth has long been a concern to travelers and explorers. This information was vital in planning for adequate supplies during voyages and for charting courses. Great effort was used by early mapmakers to show relationships between locations on Earth. Improvements in technology used for measuring distances led to increasingly more accurate maps.

Astronomers and geographers use coordinate systems for designating positions. You may be familiar with the system of longitude and latitude used by geographers. The system is regularly used to define positions on the Earth's surface. *Latitude* lines circle the planet parallel to the equator. Therefore, when stating a latitude, you must specify a number of degrees north or south of the equator. For example, 40 degrees North latitude relates to an Earth location on a line with New York in the United States; Madrid, Spain, in Europe; and Beijing, China, in Asia. Looking to the other side of the equator, 23 degrees South latitude refers to a location near Rio de Janeiro, Brazil, in South America, and Alice Springs in Australia.

*Longitude* lines on Earth run north to south, measuring angles east and west. Zero degrees longitude is defined as the line that runs through Greenwich, England, near London. The longitude for locations in North and South America is called west longitude. New York City is located at 74 degrees West longitude. Longitude for locations in most of Europe, Asia, and Africa are designated East longitude. Tokyo, Japan, is at 139 degrees East longitude.

By naming both the latitude and longitude, a very precise position on Earth can be specified. For example, New York City is located at a point where the 40-degree North latitude line crosses the 74-degree West longitude line. To be very specific, we would need to divide the latitude and longitude numbers into smaller increments called minutes of arc and seconds of arc.

## Skills

- Coordinating systems
- Using longitude and latitude
- Estimating
- Measuring
- Making models and grids

## Objectives

Students will:

- Construct a model demonstrating the longitude and latitude lines on Earth.
- Use longitude and latitude lines to find locations on their model.

## Overview

Using a balloon and string students will create a model grid system similar to the longitude and latitude lines we use on maps and globes. Students will use this grid system to identify selected positions on the model.

## Key Question

How do lines of latitude and longitude help us locate position?

## Key Concepts

- Coordinate systems are useful in helping people locate positions.
- Lines of longitude and latitude are commonly used to find geographic locations.

## Materials & Preparation

- 1 thirty cm diameter round balloon per student
  - Kite or package string
  - 1 Flexible measuring tape or meter stick per pair
  - Felt tip markers: red, black, green, blue
  - Transparent tape
  - Scissors
1. Assign two students per team.
  2. Review background information, particularly reasons for having a system of determining

locations on Earth.

3. Review the student procedures, creating a sample model if time permits.

**Management**

This activity may take one or two classes to complete. Care should be taken when using scissors.

**Reflection & Discussion**

1. What is the difference between longitude and latitude?
2. In the coordinates 40° N, 120° W, which is longitude and which is latitude?
3. Find the coordinates of a big city closest to where you live.
4. How does the balloon model differ from the real Earth?
5. How do you explain where something is when it doesn't directly lie on a line of latitude or longitude?
6. Why is it important to have coordinate systems?

**Transfer & Extension:**

1. Draw in the continents on the balloon.
2. Research and give an oral report about the methods used by astronomers to define coordinates in the sky.
3. Find several different maps of the Earth and compare them. Are some more accurate than others? What factors are involved in making a map that is accurate?
4. Research Greenwich, England, and how it became the Prime Meridian. What is meant by Greenwich Mean Time?
5. How do the time zones relate to longitude?
6. How do minutes and seconds tie into longitude and latitude coordinates?
7. Using maps in the library or on the Internet, find a few obscure or remote locations on Earth and note their latitude and longitude as specifically as possible. Challenge the students to find the coordinates of the location, providing only the name of the location as a clue.



# Latitude and Longitude

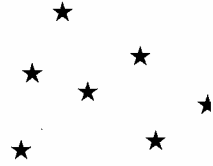

## Student Procedures

1. Get with your partner and gather the materials that you will need for the activity.
2. Blow up the balloon and tie it closed with string. The balloon represents the Earth with the balloon's opening marking the south pole of the Earth.
3. Using the tape measure, find the distance around the balloon from the north pole through the south pole and back to the north pole. This is the circumference of the balloon. Record this length here: \_\_\_\_\_ cm.
4. Cut 6 pieces of kite string this length. Fold each in half and mark the halfway point with a black marker. Fold each in half again and mark the fold with a red marker. Again fold each in half and mark with the green marker.
5. Wrap each piece of string from the south pole to the north pole, around to the south pole again and tape into place. Space the strings equally distant from each other, overlapping them at the north and south poles. Choose one to be the prime meridian (zero longitude) and use the marker to color this string blue.
6. Wrap a piece of string around the center (the equator) of the balloon, lining it up with the red marks on the longitude string. Cut it exactly the right length to fit once around the balloon's center and measure the total length of the string. Divide this number by 6 and make a mark with the black marker at each  $1/6$  point along the equator.
7. Tape the equator line into place adjusting it so the longitude lines intersect the equator at the marks at right angles.
8. Place a piece of string around the Earth above and below the equator to line up with the green marks on the longitude lines. These represent  $45^\circ$  north and south latitude. Cut to the correct length and tape into place.
9. Estimate a point halfway above and halfway below each of these new latitude lines. Cut and place strings to mark these latitude lines so that they circle the balloon.
10. Label each line of latitude as they would appear on a globe of the Earth. Be sure to designate whether or not the lines are north or south of the equator.
11. Similarly, label the longitude lines, remembering to record which lines are east and west of your prime meridian.
12. Draw six small shapes (use something simple, such as a triangle, star, circle, or square) on the balloon with a marker. Make each shape different. At least three of your marks cannot lie at the intersection of two strings.

13. Write down the shapes and their coordinates here:

Shape	Latitude	Longitude

14. Turn to your partner and have each of you call out one of the shapes and its coordinates. (For instance: "I have a star at 33 degrees N and 127 degrees W.") On your own balloon, locate the position that your partner gave you. When you find it, draw in the shape your partner indicated.
15. Repeat step 14 until all 6 coordinates have been located.

**Questions**

1. Do the shapes drawn on your balloon match those of your partner? If there are differences, go back to steps 12 and 13 to see where there was an error. Once it is fixed, describe what went wrong the first time.
2. Are all latitude lines of equal length? Are all longitude lines of equal length? When are longitude and latitude lines equal in length to each other?
3. Observe the angles made by the intersection of the latitude and longitude lines. At what angle do they intersect? Is it always the same angle?
4. How did you find the coordinates of the shapes that were not located at an intersection of the string? Is this way of determining the coordinates very accurate? How could you modify the balloon to make it more accurate?

# Chromatography

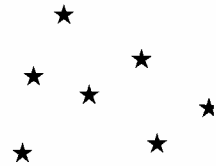

## Background

Chromatography is a technique used to separate mixtures and to analyze their individual components. Chromatography comes from the Greek words for “color writing.” It is very useful for identifying unknown substances and has many scientific applications, such as monitoring the environment and investigating evidence from a crime scene.

In liquid chromatography, mixtures are separated when they are transported along an adsorber by a solvent. (An adsorber is something to which atoms or molecules adhere and a solvent is a liquid in which the components of the mixture are dissolved.) In this activity, filter paper is the adsorber, water is the solvent, and water-soluble inks are the mixtures. Although water-soluble inks may appear to be a single color, they are usually mixtures of different pigments. When the solvent rises up the paper, it carries the ink’s different components to different heights. Among other factors, how high the component is carried depends on its solubility. (Solubility is the component’s ability to dissolve into the solvent.) The more the component “wants” to be dissolved in the solvent, the farther it will be carried before it removes itself from the solvent and adheres to the adsorber.

## Skills

- Conducting a scientific experiment
- Making observations
- Comparing and contrasting

## Objectives

Students will:

- Observe a compound separate into its component parts.
- Compare and contrast how two different solvents separate mixtures.

## Overview

In this activity, students will use filter paper as an absorber, water as a solvent, and water-soluble ink for a mixture, to demonstrate how mixtures can be separated into their component parts.

## Key Question

What can the process of chromatography reveal about a substance?

## Key Concepts

- Water-soluble inks may appear to be a single color, but they are usually mixtures of different pigments.
- The components of water-soluble inks can be separated out by the process of liquid chromatography.

## Materials & Preparation:

- 1 Piece of filter paper or coffee filter per team
  - 1 Pair of scissors per team
  - 1 Clear plastic glass or small jar per team
  - 1 Ruler per team
  - An assortment of water-soluble markers
  - Rubbing alcohol
  - 1 Pair of goggles per student
1. Assign students to cooperative groups of four.
  2. Review background information and discuss the importance of and uses for scientific testing of substances.

## Management

This activity can be completed in one class period. Be sure to review all safety rules with your students before working with the solvent solutions.

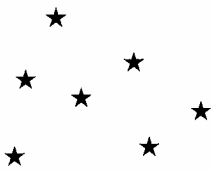

**Reflection & Discussion**

1. What happens when the water in the filter paper reaches the ink dot?
2. List the order of colors that you observe on the filter paper from bottom to top (that is, from the ink dot upward).
3. If different colored ink markers were used, what do you think would happen?
4. If you used hot water instead of cold, do you think the rate of the experiment would change?

5. Compare the results of the water solvent and the rubbing alcohol experiment. Suggest some reasons for these results.

**Transfer & Extension**

1. Have students research and write a report on how biologists or criminologists use chromatography for identification purposes.
2. Write a mystery note, left at the scene of a crime. Each suspect has a different marker. Figure out who wrote the note using chromatography.

# Chromatography

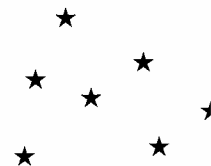

## Student Procedures

1. With the scissors, cut out a circle of filter paper LARGER than the top of the cup or jar.
2. Make two parallel cuts, 1 cm apart, from the edge to near the center of the filter paper.
3. Fold this cut strip down to hang into the center of the container.
4. With the marker, make a heavy dot 2 cm up from the bottom of the cut strip.
5. Fill the container with water so that the hanging strip touches the water but the dot is above the water level.
6. Observe what happens when the water rises up the paper. Draw what you see in the space below.
7. Continue to observe for 15 to 20 minutes.
8. Repeat the experiment, using 1/2 water and 1/2 rubbing alcohol as the solvent. Observe the change in the pattern of colors on the filter paper.

## Questions

1. What happens when the water in the filter paper reaches the ink dot?
2. List the order of colors that you observe on the filter paper from bottom to top (that is, from the ink dot upward).
3. If different colored ink markers were used, what do you think would happen?
4. If you used hot water instead of cold, do you think the rate of the experiment would change?
5. Compare these results with the water solvent and the rubbing alcohol experiment. Suggest some reasons for these results.

# Pulse and Blood Pressure

## Background

Reading of vital signs, such as pulse and blood pressure, provides important data on a person's health. In the treatment of patients in emergencies, vital signs are indispensable data. Also, vital signs provide immediate data on the state of vascular fitness and overall physical health. Many jobs require employees to be physically fit. This is especially true for astronauts because of the stresses of lift-off, re-entry, and working in a low-gravity environment.

The pulse rate is stated as a ratio of palpable (reportable by sense of touch) beats in the carotid artery or distal radial artery per minute. If the pulse is absent after palpating for nine seconds, then the patient is clinically dead and CPR must be started to keep the brain and the rest of the body from biological death. If the pulse rate is above 100 for an adult, this condition is referred to as tachycardia, "fast heart." When the pulse is below 60, it is called bradycardia, "slow heart." Many athletes' hearts pump blood so efficiently that their pulse rates may be below 60.

Blood pressure is measured by listening to the sounds of blood flow heard through a stethoscope placed on the distal brachial artery or the proximal ulnar artery while a constricting cuff gradually releases. The pressure in the cuff is visually reported in mm of mercury at two intervals: when the sounds are first heard and when the sounds can no longer be heard. These two values are, respectively, systolic (when the heart is pumping) and diastolic (between pumping). Blood pressure readings indicate the pressure that is exerted by the blood upon the wall of the vessels, especially the arteries. Knowing these values can be useful for diagnosing shock or illness.

## Skills

- Collecting data
- Recording data

## Objectives

Students will:

- Use medical instruments to measure pulse rate and blood pressure.
- Verify readings for accuracy.

## Overview

Students will use a stethoscope and a blood pressure cuff. Students will monitor and record vital signs of fellow classmates.

## Key Question

How can scientists monitor human biological systems?

## Key Concepts

- Scientists use a stethoscope and a blood pressure cuff to measure blood pressure.
- Medical data must be carefully collected and recorded.
- Heart rate is a fundamental vital sign.

## Materials & Preparation

- 1 Stethoscope per pair
  - 1 Sphygmomanometer (blood pressure cuff, valve, and meter) per pair
  - Alcohol swabs
  - Clock with a second hand
1. Obtain stethoscopes and blood pressure cuffs.
  2. Assign students to teams of two.
  3. Instruct them to use alcohol swabs to clean the earpieces of the stethoscopes between each use.
  4. Discuss background information.
  5. Discuss safety procedures, including proper placement of blood pressure cuff, only leaving the cuff on for less than 3 minutes, and not tapping on the stethoscope.

## Management

This activity will take one class period.

This activity requires a stethoscope and a blood

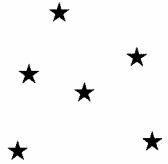

pressure cuff for each team of two. Stethoscopes, when used improperly, can cause ear damage. Monitor students closely.

**Reflection & Discussion**

1. What happens to your heart rate when you are afraid? Relaxed? Stressed?
2. Could everyone find their partner's distal radial pulse?
3. How does living in space affect the heart rate? Deep-sea diving?
4. Why do you think that high blood pressure might be dangerous?
5. Can you think of ways a person might try to lower his or her blood pressure or pulse rate?
6. Can you think of other uses for the stethoscope?

7. What other human systems need to be monitored on a regular basis?
8. How can technology help scientists accurately monitor these systems?

**Transfer & Extension**

1. First, take pulse rate and blood pressure readings and record. Then, begin exercising such as running in place or rapidly stepping up and down on a low (15 cm) bench or step for three minutes. Repeat the pulse rate and blood pressure readings and record. Are there any differences? Research reasons for your findings and report them to the class.
2. Why do you think the sphygmomanometer measures pressure in millimeters of Mercury (Hg)?

# Pulse and Blood Pressure

## Student Procedures

### PULSE

- Using your index and middle fingertips, find the distal radial pulse on your teammate. This will be found on the thumb side of the wrist with the palm facing up. If you cannot find this pulse, gently find the carotid artery in your partner's neck.
- Estimate the pulse rate by counting how many pulsations you feel in fifteen seconds and multiplying that number by four. Pulse rate is reported as pulses per minute.

	At rest	After exercise
Student 1	Pulse Rate: _____	_____
Student 2	Pulse Rate: _____	_____

Fill in pulse before exercise. Exercise and then complete the second set of measurements.

### BLOOD PRESSURE

- Carefully place the blood pressure cuff around your teammate's upper arm about two and one half centimeters above the elbow. Make sure cuff placement indicator is above the bend in the elbow. Tighten the bulb valve. Do not over tighten.
- Place stethoscope diaphragm on the bend at the elbow on the inside of the arm that has the cuff.
- Clean the earpieces of the stethoscope with an alcohol swab, then place them in your ears.
- Pump the valve until the sphygmomanometer reads 180 mm Hg. NOTE: pulsation will not be heard through the stethoscope when the cuff pressure is below the diastolic or above the systolic pressure. (Either the blood is flowing too freely or the blood flow is constricted.) Release the valve slowly and listen carefully for the first pulsating sounds. Note the number indicated by the meter at this point. This is the systolic pressure.
- Keep slowly releasing the valve and note the number at the point where you no longer hear any sounds. This is the diastolic pressure.



# STUDENT WORKSHEET

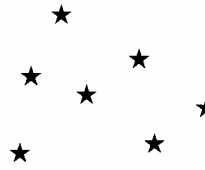

6. Report the blood pressure as the systolic number over the diastolic number, for example 110/68. Finish letting out the air from the cuff by completely releasing the valve.

	At rest	After exercise
Student 1	Blood Pressure: _____	_____
Student 2	Blood Pressure: _____	_____

Fill in blood pressure before exercise. Exercise and then complete the second set of measurements.

# Electromagnetic Spectrum

## Background

Galaxies, stars, and most of the planets in our Solar System are too far away for humans to visit. So astronomers, engineers, and other types of space scientists have to be clever to learn more about these celestial objects. Scientists have done just this by studying the light, or radiation, that comes from these objects.

Although we cannot see them, visible light comes in tiny waves, similar to waves of water. The hills and valleys are called crests and troughs. The distance between two crests is called the wavelength. Visible light waves are millions of times shorter than water waves. Not all waves are the same size; some are shorter and some are longer. We see these different *wave lengths* as colors. Sunlight may appear to be colorless white light, but it really is a mixture of many colors, or wavelengths of light. You can see some of these colors when a rainbow appears in the sky after rain. Sunlight passes through the raindrops and is bent, or refracted, depending on the wavelength of the light. The colors in a rainbow range from long to short wavelengths in the following order: red, orange, yellow, green, blue, and violet, with violet having the shortest wavelength and red the longest.

Wavelengths longer than red, or shorter than violet, cannot be seen with the human eye. Those wavelengths that are slightly longer than red light make up infrared radiation, which is the kind of radiation predominately emitted by warm objects, such as planets or people. Other wavelengths that are longer than the visible spectrum include microwaves and radio waves. The wavelengths that are shorter than the visible spectrum include ultraviolet, X-ray, and gamma rays. The shorter the wavelength, the more energy the wave has. All of these wavelengths are part of the electromagnetic spectrum; however, only a small portion of the spectrum is visible.

When you look at sunlight through a prism or diffraction grating, the resulting spectrum of light is unique to sunlight. Different types of light like neon and fluorescent light result in different spectra because of the different gases

present. Likewise, galaxies and stars are composed of different elements so their spectra reflect the types of gases present in those objects.

## Skills

- Observation
- Data interpretation
- Comparing and contrasting
- Recording data

## Objectives

Students will:

- Observe that light can be separated into a color spectrum.
- Use a diffraction grating to separate light into a color spectrum.
- Compare and contrast light sources.

## Overview

Students will use a diffraction grating to separate light into a color spectrum, then build a pinhole tube with grating on one end to observe four different light sources. They will record their observations and compare and contrast the results to draw conclusions about the light sources.

## Key Question

Is all light the same?

## Key Concepts

- Sunlight is made up of a spectrum of colors.
- Different types of light have different spectra, each unique like a person's fingerprint.

## Materials & Preparation

- 1 2.5-cm square of diffraction grating per student
- 1 Paper towel tube per student
- 1 Small piece of aluminum foil per student
- Pins (enough for students to share)
- 1 Small index card per student

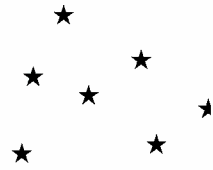

- Clear tape
  - 1 Pair of scissors per student
  - 1 Rubberband per student
  - Crayons - red, yellow, purple, blue, green, orange
  - 4 light sources including: an overhead projector (incandescent), fluorescent light, neon light, or halogen
1. Order diffraction grating from a science catalog.
  2. Cut the grating into 2.5 cm squares.
  3. Collect paper towel tubes several weeks in advance of the activity in order to accumulate enough for each student.
  4. Acquire the light sources from home, hardware stores, or specialty stores.
  5. Be sure to make a pinhole tube at home and try out the activity before doing it with students so you know how the diffraction grating works and what the spectrum looks like for each one.

**Management**

Use one class to construct the pinhole tubes. In the second class, focus on studying spectra from different light sources.

**Reflection & Discussion**

1. Why do you think different types of light have different spectra?
2. How can scientists use spectra to learn about stars and galaxies?

**Transfer & Extension**

1. Experiment with different methods of splitting light into component colors. A slit instead of a pinhole, a prism, soap bubbles, and water can also be used to diffract light. Compare and contrast the results.
2. The Sun emits radiation other than the visible spectrum. Can you identify other types of radiation? Is all radiation safe for humans? How can we experience it? What other parts of the spectrum do astronomers and space engineers use to study the universe?



# Electromagnetic Spectrum

## Student Procedures

1. Take the index card. Mark a square 2 cm in length at the center of the card. Cut the square out folding the card in half if you need help starting.
2. Carefully tape the piece of diffraction grating to the card.
3. Attach the card to one end of the paper towel tube, centering the grating in the middle of the hole. Tape two sides of the card in place. Carefully cut straight lines into the card so that it will bend to fit around the tube. Tape the rest of the card firmly in place.
4. Carefully cover the other end of the paper towel tube with the aluminum foil, stretching the foil tightly across the tube hole. Use the rubberband to hold the foil in place.
5. Take the pin and gently poke a small hole in the center of the foil. Be careful not to rip the foil.
6. Your teacher will direct you to point the tube toward four light sources and look through the diffraction grating. *Do NOT look directly at the Sun.* This can lead to permanent eye damage!
7. Record what you see on the worksheet as accurately as possible.
8. Why do think the spectra are different?

# Electromagnetic Spectrum

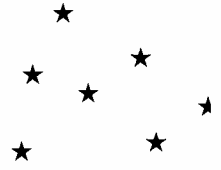

Rotate the diffraction grating until you see color on the left and right of the light source. Draw the colors in the order you see them on both sides of the light source with crayons. Allow the colors to touch the top edge and bottom edge of the guidelines shown below. The small circle in the center represents the light source.

Light Source 1: \_\_\_\_\_

Light Source 2: \_\_\_\_\_

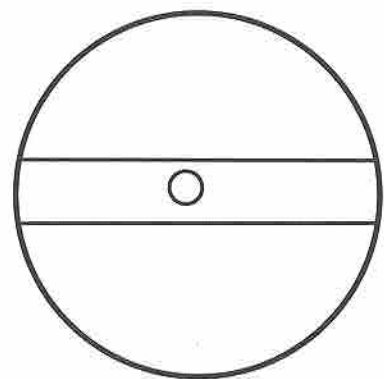
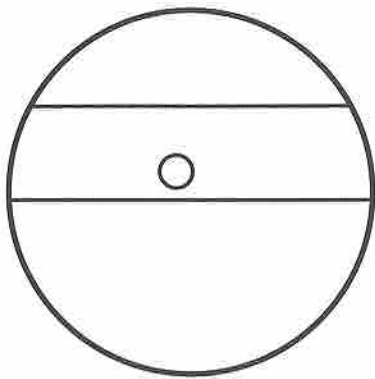

Light Source 3: \_\_\_\_\_

Light Source 4: \_\_\_\_\_

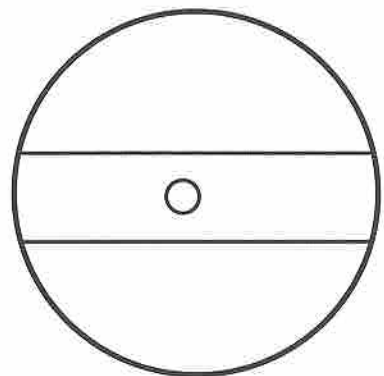
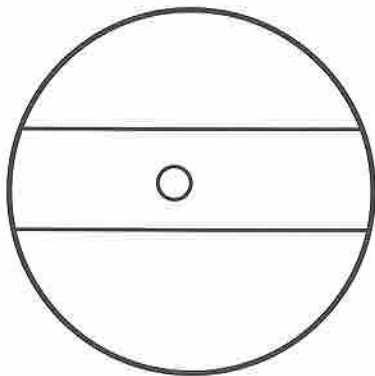

# Reading Equipment with Scales

## Background

In an effort to fully understand our universe and to better prepare for future missions, scientists examine a wide range of measurements about our Solar System and beyond. Scientists use various units of measurement and different types of scales in order to ensure precise and uniform measurement.

Scientists use the International System of Measurement, which is a version of the metric system. In the metric system, a basic unit of measure is used for each type of measurement, and prefixes are affixed to this basic unit to make describing amounts easier.

The liter is the metric unit for measuring volume. Prefixes, added to “liter”, are used to show fractional parts of the liter and multiples of liters, as follows.

Milliliter	1/1000 of a liter
Centiliter	1/100 of a liter
Deciliter	1/10 of a liter
Decaliter	10 liters
Hectoliter	100 liters
Kiloliter	1000 liters

## Skills

- Measuring
- Collecting data
- Math
- Science

Measurement	Unit	Measured with
Length	Meter, Kilometer	Meter Stick
Volume	Liter, Milliliter	Graduated Cylinder
Weight or Mass	Gram, Milligram, Kilogram	Scale
Temperature	Degree (Celsius)	Thermometer
Speed	Kilometers/Hour	Speedometer
Electrical current	Amperes	Ammeter

## Objectives

Students will:

- Apply the metric system to reading various forms of measuring devices.
- Use a meter stick to find the length, width, and height of several objects.
- Calculate volume, area, and density.

## Overview

Students will practice reading an ammeter, a graduated cylinder, a meter stick, and a balance. Students will calculate area, volume, and density.

## Key Question

How can instruments of measure assist us in scientific investigation?

## Key Concepts

- Technology is essential to scientific investigation.
- Technology can assist us by providing tools for analysis.
- The more advanced technology becomes, the more precise the measurements, leading to greater accuracy and insight into phenomena in our Solar System.

## Materials & Preparation

Per team:

- 5 different objects for students to weigh and measure
  - 1 Triple beam balance
  - 1 Meter stick
  - 3 Graduated cylinders of various sizes
  - 1 Ammeter
1. Obtain materials listed above.
  2. Fill all three graduated cylinders with different amounts of water.
  3. Assign students to teams with cooperative roles.

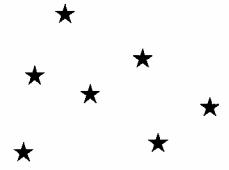

- 4. Discuss the metric system.
- 5. Review with the students the formulas for volume, area, and density.

**Management**

This lesson should take one class period. You can order ammeters from a science catalog.

**Reflection & Discussion**

- 1. How can the use of measuring devices assist us in everyday life?
- 2. How can we create new measuring units or devices?
- 3. Why is it important to use the metric system?
- 4. Which is the largest unit of measure: milliliter, centiliter, or deciliter? When is it appropriate to use each?

**Transfer & Extension**

- 1. Convert recipes into metric measurements and have the students make the dishes based on the new units.
- 2. Interview an electrician to find out information about an ammeter. Why is it used? How is it used?
- 3. Use an ammeter to determine which materials are good and bad conductors of an electrical current.
- 4. Research and report on the National Institute of Standards and Technology.

# Reading Equipment with Scales

## Student Procedures

1. For questions 1-6, use the graduated cylinders to practice reading and writing measurements of volume.
2. For questions 7 and 8 use the pictures of the ammeter dials (at right) to practice reading and writing measurements of electrical currents. Use milliamps (mA)
3. Use the balance and the meter stick to weigh and measure five objects provided by the teacher.
4. Use the following formulas to calculate the surface area, volume, and density of each object.

(Volume= Length x Width x Height) (Area= Length x Width) (Density =  $\frac{\text{Mass}}{\text{Volume}}$  )

5. Record your data in the chart below.

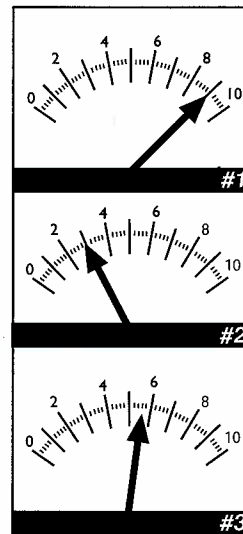

## Reflection & Discussion

1. The value of each line in cylinder #1 represents \_\_\_\_\_ ml.
2. \_\_\_\_\_ ml is the volume of the liquid in graduated cylinder #1.
3. The value of each line in cylinder #2 represents \_\_\_\_\_ ml.
4. \_\_\_\_\_ ml is the volume of the liquid in graduated cylinder #2.
5. The value of each line in cylinder #3 represents \_\_\_\_\_ ml.
6. \_\_\_\_\_ ml is the volume of the liquid in graduated cylinder #3.
7. \_\_\_\_\_ is the value of the long bold line between the 2 and 4 on each of the ammeters.
8. Each line on the ammeters is \_\_\_\_\_ mA more than the one before it. Read the ammeters and write the number of milliamps represented on each.  
 Ammeter #1 \_\_\_\_\_ mA  
 Ammeter #2 \_\_\_\_\_ mA  
 Ammeter #3 \_\_\_\_\_ mA
9. Do all graduated cylinders look the same?
10. Even if they look different, are all graduated cylinders similar in they way they are used?



# STUDENT WORKSHEET

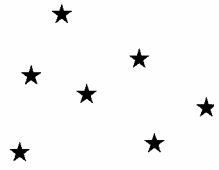

	Length	Width	Height	Area	Volume	Density
Object #1						
Object #2						
Object #3						
Object #4						
Object #5						

# Average Temperature

## Background

The Earth orbits the Sun in an elliptical path that is very nearly a circle. In early January each year, the Earth is nearest to the Sun; in July of each year, the Earth is farthest from the Sun.

Earth experiences seasons because its axis of rotation is tilted with respect to its orbital plane. The tilt of Earth's axis causes surface temperature variations as the Earth orbits the Sun. In the northern hemisphere during the summer, the Sun rises north of east and takes a very high path across the sky to set north of west. The Sun is in the sky for a longer period of time and the rays of sunlight strike the Earth at a high angle. In winter, the Sun rises to the south of east, travels a low path across the southern sky, and sets to the south of west. The angle of incident sunlight striking the northern hemisphere is lower. A low angle of sunlight is very inefficient at heating the Earth's surface because the energy is spread out over a larger area. Also in the winter, the Sun is up for a shorter period of time. The combination of these factors causes cold winter temperatures.

Temperatures also differ during night and day. In general, the temperature in daytime is higher than at night because the Sun's energy warms the Earth and its atmosphere during the day. Other causes for varying temperatures include changing amounts of cloud cover and the occurrence of atmospheric weather fronts.

## Skills

- Reading a thermometer
- Averaging
- Graphing

## Objectives

Students will:

- Record temperature data four times a day for one week.
- Calculate and analyze average temperatures.

- Design and construct a temperature vs. time line graph.

## Overview

Students will record the temperature four times a day for one week. They will calculate the daily average temperature, then calculate the average weekly temperature. Once all of the averages are completed, they will create a temperature vs. time line graph.

## Key Question

How can scientists use data to determine the average climate of a particular region?

## Key Concepts

- Data collection
- Analyzing data sets
- Conducting scientific investigations
- How scientists use technology to help them in their research

## Materials & Preparation

- 1 Thermometer (F)
  - 1 Student Worksheet per student
  - Graph paper
  - Red & black pencils or markers
1. Assign students to cooperative roles, discuss concepts presented in the Background section, then have the students do the following:
  2. Choose four different times in the school day to collect temperature data. Each time must be at least an hour apart.
  3. At each of the chosen times during "Day 1," the students will record the temperature in degrees Fahrenheit on the Student Worksheet.
  4. Convert the temperature to degrees C. Use the formula:  $^{\circ}\text{C} = (^{\circ}\text{F} - 32) \times 5/9$ .

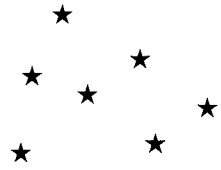

5. Find the average temperature for "Day 1."  
Average temperature = (temp. time #1 + temp. time #2 + temp. time #3 + temp. time #4)/4
6. Plot each temperature for Day 1 on the graph in black.
7. Plot the average temperature for Day 1 on the graph in red.
8. Repeat steps 2 - 7 for each consecutive day (Days 2 - 5).
9. At the end of Day 5, find the average temperature for the week.  
Average temperature = (Average temp. Day 1 + 2 + 3 + 4 + 5)/5

**Management**

This activity will take a few minutes a day for one week. At the end of the week, you will need about one class period to discuss the data and for students to complete the line graph.

**Reflection & Discussion**

1. What factors contributed to the low and high temperatures on each day?
2. If a particular day had a higher or lower

average temperature than the weekly average, give possible reasons for this phenomenon.

3. Choose one of the following occupations: farmer, city planner, fire fighter, or school principal.  
How does knowing this type of temperature information on a regular basis help them do their job?

**Transfer & Extension**

1. Collect additional data regarding pressure, humidity, and rainfall.
2. Using local newspaper or TV weather reports, collect data from other regions of the world. Compare your results.
3. Determine actual average temperatures for the classroom. Take temperatures at several locations within the room and determine the average.
4. Research information about the temperatures for four selected dates such as the winter and summer solstices and the fall and spring equinoxes. Do this for a northern hemisphere site and a southern hemisphere site.

# Average Temperature

## Student Procedures

1. Choose four different times in the school day to collect temperature data. Each time must be at least an hour apart.
2. At each of the chosen times during "Day 1," record the temperature in degrees Fahrenheit on the chart below.
3. Convert the temperature to degrees C. Use the formula:  $^{\circ}\text{C} = (^{\circ}\text{F}-32) \times 5/9$
4. Find the average temperature for "Day 1".

$$\text{Average temperature} = (\text{temp. time \#1} + \text{temp. time \#2} + \text{temp. time \#3} + \text{temp. time \#4})/4$$

5. On the graph, plot each temperature for Day 1 in black.
6. On the graph, plot the average temperature for Day 1 in red.
7. Repeat steps 2-6 for each consecutive day (Days 2-5).
8. At the end of Day 5, find the average temperature of the week.

$$\text{Average temperature} = (\text{Average Temperature Day 1} + 2 + 3 + 4 + 5)/5$$

## Reflection & Discussion

1. What time of day had the highest temperature? Why?  
\_\_\_\_\_
2. What factors contributed to the lowest temperature on a daily basis?  
\_\_\_\_\_  
\_\_\_\_\_
3. If a particular day had a higher or lower average temperature than the weekly average, give reasons for this phenomenon.  
\_\_\_\_\_  
\_\_\_\_\_
4. Choose one of the following occupations: farmer, city planner, fire fighter, or school principal.  
How does knowing this type of temperature information on a regular basis help them do their job?  
\_\_\_\_\_  
\_\_\_\_\_  
\_\_\_\_\_

# STUDENT WORKSHEET

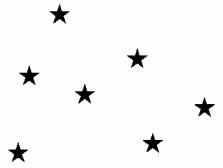

	Temp. #1		Temp. #2		Temp. #3		Temp. #4		Average Temp.	
	°F	°C	°F	°C	°F	°C	°F	°C	°F	°C
Day #1										
Day #2										
Day #3										
Day #4										
Day #5										

<b>Temperature</b>																				
		<b>Time</b>																		

# Mission Patch

## Background

While in training, the crew of every Space Transport System (STS) designs a patch that identifies its unique mission. Since the first mission in April 1981, more than 450 astronauts have participated in more than 100 missions. Most Shuttle crews consist of the commander, a pilot, mission specialists, and payload specialists. Each member of the crew contributes to the patch design. The team uses color, shape, images, and text to represent different aspects of their mission. Here are two examples.

**STS 51-L CREW INSIGNIA**—This mission patch symbolizes the mission of shuttle flight 51-L, to fly and to teach. The shuttle, being launched from the United States of America, encircles the planet to signify its U.S. presence in space to explore new frontiers. The shuttle in flight with open cargo doors represents the 51-L mission to launch a communication satellite (TDRSS), to collect data from Comet Halley, and to conduct scientific experiments. The apple next to the teacher's name signifies the educational mission of the crew to touch the future through the lessons taught in space. The scene is encircled by the surnames of the crew members. They were astronauts Francis R. (Dick) Scobee, commander; Michael J. Smith, pilot; Ron McNair, Ellison Onizuka, and Judy Resnik, all mission specialists; Greg Jarvis, payload specialist; and Christa McAuliffe, teacher.

**STS-98 CREW INSIGNIA**—This mission marked a major milestone in assembly of the International Space Station (ISS). Atlantis' crew delivered the United States Laboratory, Destiny, to the ISS. The crew patch depicts the Space Shuttle with Destiny held high above the payload bay just before its attachment to the ISS. Red and white stripes, with a deep blue field of white stars, border the Shuttle and Destiny to symbolize the continuing contribution of the United States to the ISS. The constellation Hercules, seen just below Destiny, captures the Shuttle and Station's team efforts in bringing the promise of orbital

scientific research to life. The reflection of Earth in Destiny's window emphasizes the connection between space exploration and life on Earth. Shuttle crew members are: Kenneth Cockrell, commander; Mark Polansky, pilot; and mission specialists Robert Curbeam, Marsha Ivins, and Thomas Jones.

## Skills

- Team building
- Team patch design

## Objectives

Students will:

- Identify attributes of mission patches.
- Design, draw, and describe the attributes of their own mission patch.

## Activity Overview

Students will work in teams of four. They will read two mission patch descriptions and observe the patches. Using shape, color, images, and text, they will design their own crew patch.

## Key Question

How can a team create a graphic design that represents all of the members and the team mission?

## Key Concept

- Shape, color, images, and text can be used to create a graphical representation of a mission.

## Materials & Preparation

- Mission Patch Descriptions
  - Drawing supplies
1. Divide students into teams of four.
  2. Using a thinking web have students brainstorm ideas for their mission patch.
  3. Once students have developed some ideas, they need to come to a consensus on how to design the patch. **Note:** Because this is a team-building activity, it is important to let students come to a consensus rather than to vote on the design.

# TEACHERS GUIDE

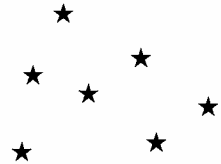

4. Once consensus has been reached, students will begin designing their patch.
5. Once students have completed their patch design, assemble a gallery of patches on the wall.
6. Once all of the patches are on the wall, have students do a gallery walk.
7. Have students look at each patch and write down their interpretation of the design.
8. Have students compare their interpretations of each design to the original patch description.

## Management

This activity can be completed in one class period.

## Reflection & Discussion

1. If you will all be flying the same mission, how come each of the patches are different?

2. What was difficult about reaching a consensus?
3. What kind of consideration went into planning your class patch?
4. How can visual images inspire teamwork and group missions?

## Transfer & Extension

1. Research upcoming shuttle missions and their mission's patch. Keep a wall of patches for each shuttle mission throughout the school year.
2. Boy Scouts/Girl Scouts get badges for skills they master. What do their badges represent?
3. Write to your regional NASA center for current mission patch stickers or contact CORE.
4. Create a mission patch for any other programs students may be involved in. (Scouts, Band, Sports, Community Service)

# Mission Patch Description

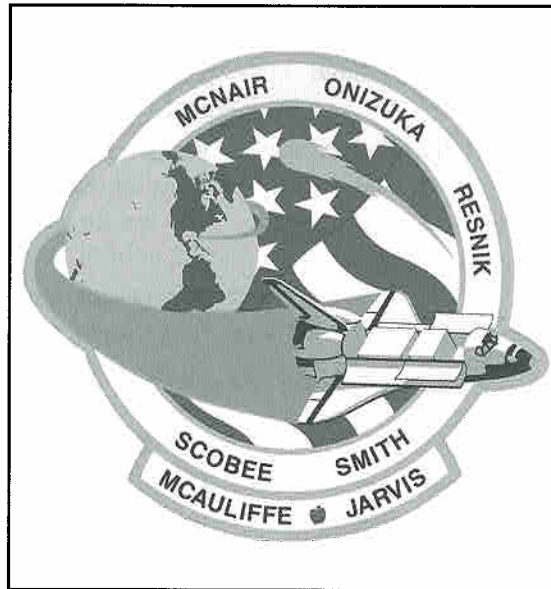

## 51-L Mission Patch

This patch symbolizes the mission of shuttle flight 51-L, to fly and to teach. The shuttle, being launched from the United States of America, encircles the planet to signify its U.S. presence in space to explore new frontiers. The shuttle in flight with open cargo doors represents the 51-L mission to launch a communication satellite (TDRSS), to collect data from Comet Halley, and to conduct scientific experiments. The apple next to the teacher's name signifies the educational mission of the crew to touch the future through the lessons taught in space. The scene is encircled by the surnames of the crew members. They were astronauts Francis R.(Dick) Scobee, commander; Michael J. Smith, pilot; Ron McNair, Ellison Onizuka, and Judy Resnik, all mission specialists; Greg Jarvis, payload specialist; and Christa McAuliffe, teacher.



# Mission Patch Description

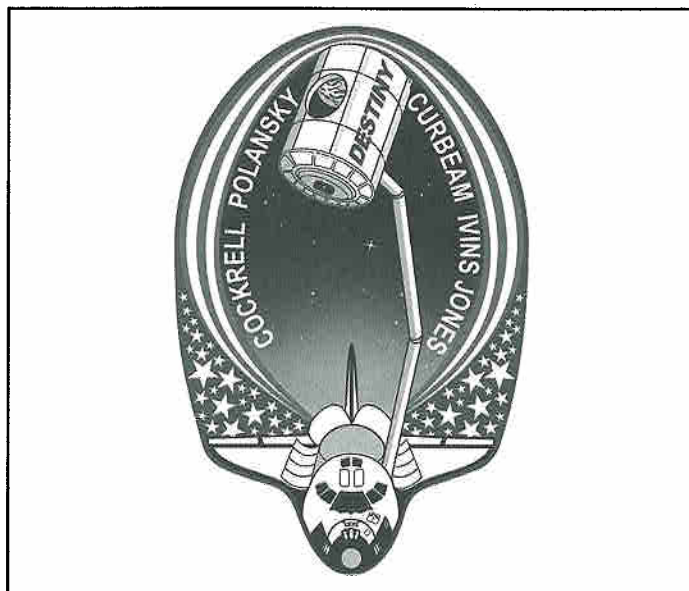

## STS-98 Mission Patch

This mission marked a major milestone in assembly of the International Space Station (ISS). Atlantis' crew delivered the United States Laboratory, Destiny, to the ISS. The crew patch depicts the Space Shuttle with Destiny held high above the payload bay just before its attachment to the ISS. Red and white stripes, with a deep blue field of white stars, border the Shuttle and Destiny to symbolize the continuing contribution of the United States to the ISS. The constellation Hercules, seen just below Destiny, captures the Shuttle and Station's team efforts in bringing the promise of orbital scientific research to life. The reflection of Earth in Destiny's window emphasizes the connection between space exploration and life on Earth. Shuttle crew members are: Kenneth Cockrell, commander; Mark Polansky, pilot; and mission specialists Robert Curbeam, Marsha Ivins, and Thomas Jones.



T E A C H E R S   G U I D E

# Press Conference

## Background

NASA holds a press conference after every mission. Each press conference lasts approximately one hour and covers general information and specific mission data that is presented by the crew and Mission Control staff. Tapes of press conferences are available from your regional NASA Teacher Resource Center. This information is also available at NASA Spacelink on the Internet.

Post-visit activities are vitally important to the success of the overall Challenger mission. They provide an opportunity for the students to reflect on their activities at the Challenger Learning Center. Also, the teacher can use this time to assess the students' knowledge of key concepts and relate them to other curriculum materials.

On the day after your Challenger mission, conduct a debriefing session. Each team should relate its activities while at the Challenger Learning Center and describe how these activities were essential to the success of the entire mission.

## Skills

- Writing to inform
- Public speaking
- Self-reflection

## Objectives

Students will:

- Prepare a statement about their duties during the mission.
- Prepare answers to specific questions about those duties.
- Create a set of criteria for an informative press conference.

## Overview

After a Challenger mission, students will conduct a debriefing session. In teams, students will prepare reports in the form of a press conference that reflect their activities while at

the Challenger Learning Center and they will describe how their activities were essential to the success of the entire mission.

## Key Questions

- What happened at the Challenger Learning Center?
- What part of the Learning Center mission were you responsible for? How successful was it?
- How can you express personal ideas and experiences to others?

## Key Concept

- Students use visual, written, and verbal communications to express their ideas.

## Materials & Preparation

- 1 Video camera and monitor
- 2 long tables
- Decorations
- Costumes
- Props
- Panel of Crew Representatives: (8 students, 1 from each team)
- Panel of Reporters: 6-8 students or parents and administrators
- Camera Crew: 2-4 students

1. Assign each crew from the mission a representative to speak on the panel.
2. Each crew is given some sample questions that might be asked. They must come to consensus with their answers.
3. Each crew elects a recorder to write the crew's responses to the questions.
4. Each crew will also write a prepared statement regarding the mission. This will be reported before the questions from the panel begin. Information for this statement may be taken from the DATA LOGS.
5. Select a panel of news reporters. Give each of them a set of sample questions for each crew.

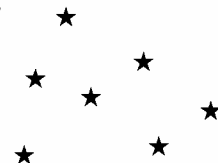

6. Reporters are required to write at least one additional question, which is not included in any of the samples. These are to be reviewed by the moderator (teacher) before the press conference.
7. Ask each reporter to be prepared to clarify his/her questions during the conference.

**Press Day**

1. Select a camera crew (optional). Assign the camera crew the task of setting up the tables and chairs and reviewing good filming techniques.
2. Arrange the monitor so that the students in the audience can see it.
3. The moderator starts the press conference by introducing the crew members.
4. Each crew representative gives the prepared report.
5. The reporters select from their questions one at a time. They must address the person to whom the question is directed. The representative of the crew responds before another question is asked. The moderator reserves the right to clarify a question or an answer.
6. The students in the audience may be required to agree or disagree or clarify their representative's response.

**Management**

This activity will take several class periods to prepare and complete depending on the level of sophistication.

Be sure students speak facing the camera.

Discuss other public speaking tips as desired.

**Reflection & Discussion**

1. List some ways in which knowing how to use science, math, technology, and communication helps the mission.
2. List some ways in which the simulated mission was like real life.
3. What did you learn from the mission:
  - about yourself?
  - about teamwork?
  - about problem-solving?
  - about science?
4. Did the mission give you any help in deciding a career or job for the future?
5. How did you reach consensus on making decisions?
6. Was the mission successful?
7. What happened at the Learning Center?
8. What were your roles and responsibilities?
9. How did your team contribute to the success of the mission?

**Transfer & Extension**

1. Prepare this press conference and submit it to a local TV station or newspaper.
2. Invite other classes, parents, and the principal to learn about your experience.
3. Prepare the press conference like a news story for television or as a newspaper special feature in the style section.
4. Create a multimedia press conference for your band, scouts, class assignments, family events, etc.

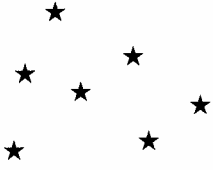

# Press Conference

## Student Procedures

1. Fill in the blanks with your specific team's information. Write this statement in your own words and use it during the Press Conference. Give this form to your teacher to file. Feel free to add more information if you think it is important.

As members of the \_\_\_\_\_ team, our purpose was to \_\_\_\_\_

\_\_\_\_\_. Our responsibilities included \_\_\_\_\_

(Names) \_\_\_\_\_ and \_\_\_\_\_ began as Mission Controllers, and \_\_\_\_\_ and \_\_\_\_\_ began in the Spacecraft. Spacecraft personnel followed task cards to carry out important activities. Mission controllers supervised and recorded data from all activity in the Spacecraft.

We were able to complete (some, most, all) \_\_\_\_\_ of our tasks. Our most important accomplishment was \_\_\_\_\_

The data generated on our mission will be analyzed for potential close encounters or for future needs by the spacecraft. This data is also important because it adds to our knowledge about space travel and

## Reflection & Discussion

1. What have we learned from this mission that will help us make important decisions about our own planet?
2. What would you suggest be added to the next mission as an important improvement?
3. What was the most exciting part of your mission?

# Communication

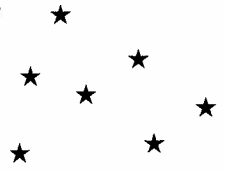

## Background

At the Challenger Learning Center, students accomplish their team goals by following directions on task cards. Each team has two sets of task cards, one for the students at Mission Control and one for the students in the Space Station. The role of Mission Control is to monitor the success of the mission and health/well-being of the crew. They must also assist the Space Station team when needed and when emergencies occur to ensure that the Space Station team is able to complete the activity. Mission Control must always be aware of where the Space Station team is in the task cards so they can relay vital information needed to complete the task. The spacecraft team must follow the directions on the task card step-by-step to accomplish their task. It is important to always read and follow the directions in order to complete a task before going on to the next task card.

## Skills

- Following clear and concise directions
- Creating clear directions

## Objectives

Students will:

- Use task cards to construct a module.
- Write a series of sequential directions to complete a task.

## Overview

In teams of two, students each design a simple object using Lego® bricks. They then create a set of instructions for making their object. They take turns giving verbal instructions to their partner for the construction of their object. During the construction, students are in constant one-to-one verbal contact with their partner.

## Key Question

How can we create clear and effective instructions to complete a task?

## Key Concepts

- Clear spoken and written language is essential to accomplish tasks.
- Reading and following instructions are skills essential for success.

## Materials & Preparation

Each student needs:

- 10 Lego® bricks of a variety of shapes (and colors)
- Instruction template sheets

1. Pair students into teams of two.
2. Give every student a set of Mission Control task cards and Space Station task cards.
3. Have pairs of students sit next to each other with some sort of border set up between them so that they cannot see each other's work.
4. Working individually, students make a 'module' from the Lego blocks and write down the stages for its construction into Mission Control taskcards numbered 7, 8, 9, and 10.
5. As students complete their instructions, they cut them into cards and make the set of cards into a manual.
6. Assign one student to use the Mission Control task cards and the other student to use the Space Station task cards.
7. Mission Control will transmit instructions for building the module.
8. Once students have completed building the module, have them switch roles and build their teammate's module.

## Management

This activity is begun individually and completed in pairs and will take one class period.

The emphasis on clear unambiguous communication is important to the Mission. In order to match the task to students'

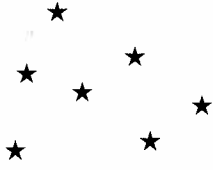

capability, you can vary the complexity of the shape of the Lego module: a 2-dimensional shape with simple bricks for some students through to a complex 3-dimensional shape with a wider variety of bricks for others. To give students a start, you may find it helpful to discuss what to call the various blocks and to use the example set of instructions. Selecting a distinctive color for each type of block gives a powerful additional cue for less-able students.

**Reflection & Discussion**

1. How clear were your instructions?
2. How well could your partner carry out your instructions?
3. How do you make sure your instructions can be understood?
4. What sorts of things go wrong if communication is unclear?

**Transfer & Extension**

1. Design a space probe with building blocks, then write directions for making the space probe. Sit back-to-back with a partner and transmit the directions to your partner. Was your partner able to build the space probe correctly? How could you improve the directions?

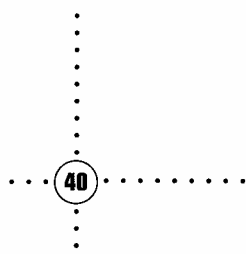

# Communication

## Mission Control Task Cards

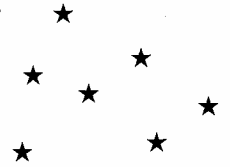

### Getting Started

1. Your job in Mission Control is to transmit instructions for constructing the Lego module you have designed.
2. Build a structure using the Legos. On Mission Control task cards 7-10, write instructions for building your module.
3. Choose which of you will be Mission Control and Space Station first. Follow the appropriate task cards in order to build the module.
4. When you "send" a message to your teammate, please use the proper procedures. Say only what is given in this manual. Clear communication is vital to the success of your mission.
5. When your teammate informs you that he/she is ready to begin, turn to the next card.

MISSION CONTROL TASK CARD 1

### Test Run: Instructions for building the example Lego Module

1. When you "send" a message to your teammate, please use the proper procedures. Say only what is given in this manual.
2. Send a verbal message to your teammate. You should say:  
**Space Station, this is Mission Control:**  
**Do you have the Lego blocks as follows?**
  - 4 blocks each with 2 rows of 2 buttons "2 x 4 blocks".
  - 4 blocks each with 2 rows of 2 buttons "2 x 2 blocks".**Are you ready to begin? OVER.**
3. When your teammate informs you that he/she is ready to begin, turn to the next card.

MISSION CONTROL TASK CARD 2

4. "Send" the following message to your teammate. You should say:

**Space Station, this is Mission Control:**

**We will now construct the first section of the Lego module.**

**Place a 2 x 2 block, a 2 x 4 block, and another 2 x 2 block to make a line.**

**OVER.**

5. You may be asked to repeat instructions. Do so quickly. Wait until your teammate tells you that he/she is ready to proceed before moving to the next card.

**MISSION CONTROL TASK CARD 3**

6. When your teammate is ready to proceed, send this message. You should say:

**Space Station, this is Mission Control:**

**Place two 2 x 4 blocks exactly on top to lock the bottom row together.**

**OVER.**

7. Turn to the next card.

**MISSION CONTROL TASK CARD 4**



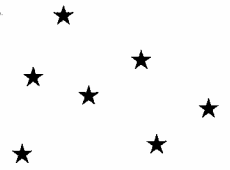

- 8.** When your teammate is ready to proceed, send this message. You should say:

**Space Station, this is Mission Control:**

**Now add a 2 x 2 block, a 2 x 4 block, and another 2 x 2 block to form the top row and complete the module.**

**OVER.**

- 9.** Turn to the next card.

**MISSION CONTROL TASK CARD 5**

- 10.** When your teammate is ready to proceed, send this message. You should say:

**Space Station this is Mission Control:**

**The assembled module should be a rectangle three blocks high and eight studs long.**

**Is this correct?**

**OVER.**

- 11.** Repeat previous instructions as necessary.

**MISSION CONTROL TASK CARD 6**

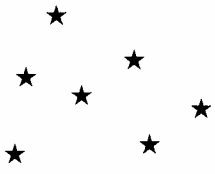

**Construct your own Lego module**

Write instructions for building your Lego module in the spaces on taskcards 7, 8, 9, and 10.

1. Send a start-up message to your teammate. You should say:

**Space Station, this is Mission Control:**

**Do you have the Lego bricks as follows:**

---

---

---

**OVER.**

2. When your teammate replies that he/she is ready, turn to the next card.

MISSION CONTROL TASK CARD 7

3. Send a message to your teammate. You should say:

**Space Station, this is Mission Control.**

---

---

---

**OVER.**

4. When your teammate replies that he/she is ready, turn to the next card.

MISSION CONTROL TASK CARD 8

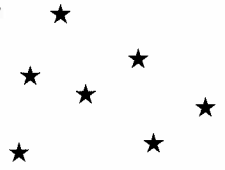

MISSION CONTROL TASK CARD 9

5. Send a message to your teammate. You should say:

Space Station, this is Mission Control:

---

---

---

OVER.

6. When your teammate replies that he/she is ready, turn to the next card.

MISSION CONTROL TASK CARD 10

7. Send a message to your teammate. You should say:

Space Station, this is Mission Control:

---

---

---

OVER.

8. When your teammate replies that he/she is finished, see if their module matches your original design.

# Communication

## Taking instructions from Mission Control

1. Your job in the Space Station is to construct a Lego module with guidance from Mission Control. You have all of the materials necessary to build the Lego module and your teammate in Mission Control has all of the necessary instructions.
2. You will have one-to-one contact with your teammate in Mission Control.
3. You will need to follow the step-by-step instructions transmitted by your teammate and construct the Lego module according to those instructions.
4. When you send a message to your teammate, please use the proper procedures. Say only what is in this manual.
5. Make sure you have all the necessary materials. You will need the correct Lego blocks.

SPACE STATION TASK CARD 1

## Communication protocols:

**READY:** When your teammate asks if you are ready to begin, "send" your reply. you should say:

**Mission Control, this is Space Station.**

**I am ready to begin.**

**OVER.**

**HELP:** Follow the instructions carefully. If you need the instructions repeated, send a message to your teammate. You should say:

**Mission Control, this is Space Station**

**Repeat that instruction.**

**OVER.**

**PROCEED:** When you have completed an instruction, send the following message. You should say:

**Mission Control, this is Space Station.**

**I have completed those instructions. Proceed.**

**OVER.**

SPACE STATION TASK CARD 2

# Mission Survival

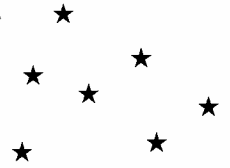

## Background

To survive in a hostile environment, basic human requirements must be met. Earth's atmosphere provides the air we need to breathe, atmospheric pressure that the human body requires to function, and protection from much of the harmful radiation from the Sun. On Earth, some basic human needs include food, water, shelter, and clothing. The body can go without food longer than it can go without water. Shelter provides protection from the elements such as extreme temperatures and inclement weather. Likewise, proper clothing allows humans to live and function in comfort. Usually, these needs are easily met. However, in extreme situations, humans must prioritize their needs in order to survive. Tools, resources, and skills may be necessary to obtain food and water or to construct proper shelter and make clothing. Communication can be key to survival as well. In a hostile environment, successful teamwork may be all that stands between the life and death of individuals.

## Skills

- Reaching consensus
- Problem solving
- Team building
- Communication skills

## Objectives

Students will:

- Discuss and reach consensus on items to include in a survival kit in an emergency situation.
- Decide, evaluate, and formulate problem solving skills to plan a course of action.
- Establish criteria for the contents of a survival kit.
- Identify hostile environmental elements to be overcome in Antarctica.
- Compare and contrast the hostile environment of Antarctica to other places on Earth or in the Solar System.

## Overview

This activity is a classic way to generate discussion, problem solving, and consensus building around survival issues in a hazardous environment in the event of a hypothetical emergency situation. Students are asked what to do in the event they are stranded in Antarctica several days walking distance from base camp. The class must make a plan and prioritize those items needed for a survival kit.

## Key Question

Why is reaching consensus and prioritizing essential to making team decisions?

## Key Concepts

- Good communications skills are part of teamwork.
- Reaching a consensus and prioritizing are important skills for successful teamwork.

## Materials & Preparation

1. Based on the scenario, students will plan what they would do. Each group must reach consensus. Should they stay put near the plane or head for the base camp?
2. Student/teams will need to come to consensus on their answers (i.e., complete agreement).
3. Have students put a star next to the essential items for their survival kit.
4. As a class or in groups of six, have students answer the questions on the student worksheet.

## Management

This activity should take one class period to complete. You can break the class into small groups of six students and have teams share their solutions with the class, or do the activity as an entire class.

The teacher should focus less on “the answer” than on promoting critical thinking and consensus building skills. Pay attention to the leadership that will emerge in the group

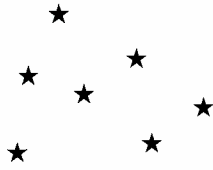

work. It may provide you with some surprising insight into your students and impact how you assign them to roles for the Learning Center mission.

**Reflection & Discussion**

1. What do humans need for survival in a hostile environment?
2. What items are “nice to have,” but not essential?
3. Why is it important to have emergency plans in place?
4. What kind of emergency plans do you know in case of a fire, earthquake, or power outage?
5. What kind of emergency measures are on airplanes, cars, or in homes?

6. What was difficult about reaching consensus? What would make it easier next time?
7. Compare and contrast survival in Antarctica to planning to live on the Moon, Mars, or a long duration space mission.

**Transfer & Extension**

1. Plan and create a first aid kit for home use.
2. Find out the skills needed for wilderness survival training, where a person spends several days alone living off the land.
3. What contingency plans are in place for the Space Shuttle, the International Space Station, or a space suit?
4. What can your class do to help those that survive a natural disaster?

# Mission Survival

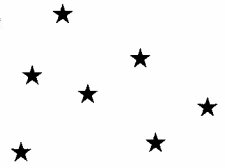

Life in a hostile environment requires careful thinking and planning to meet human survival requirements. In many respects, Antarctica is an excellent training ground for a long duration, human mission on Mars. Like Mars, Antarctica is barren and typically very cold. Unlike Mars, Antarctica has air, atmospheric conditions fit for humans, and access to water.

You are part of six-person crew on its way to Antarctica to collect meteorites, which are easily found in the white snow. Just short of base camp, the plane develops electrical problems and crashes. Miraculously nobody is seriously injured, but all radio communication has been permanently damaged.

The pilot estimates that the team is approximately a five-day walk from base camp. Another plane with a second crew will be flying out to camp in two weeks.

1. As a class or in groups of six, answer the questions below. You will need to come to consensus on your answers (i.e., complete agreement).

Based on the scenario above, plan what you would do. Your group must reach consensus. Should you stay near the plane or head for the base camp?

2. The items below survived the crash. If you decide to head for base camp, you can only take what you can carry with you to survive until you can get help or be rescued. What items are essential for your survival kit?

Put a star next to the essential items for your survival kit.

- |  |  |
|--|--|
| <input type="checkbox"/> Parachutes (2)                                | <input type="checkbox"/> Twine                             |
| <input type="checkbox"/> Matches (1 box)                               | <input type="checkbox"/> Canned chili (2 boxes of 48 cans) |
| <input type="checkbox"/> Sleeping bags (2)                             | <input type="checkbox"/> Mess kits (6)                     |
| <input type="checkbox"/> Long underwear                                | <input type="checkbox"/> Make-up compact with mirror       |
| <input type="checkbox"/> Water (12 gallons)                            | <input type="checkbox"/> Flare gun                         |
| <input type="checkbox"/> Pick axe                                      | <input type="checkbox"/> Portable radio                    |
| <input type="checkbox"/> Flashlight                                    | <input type="checkbox"/> Thermal boots                     |
| <input type="checkbox"/> Candy bars (1 box of 24)                      | <input type="checkbox"/> Hammer                            |
| <input type="checkbox"/> Fruit (1 crate of bananas)                    | <input type="checkbox"/> Screwdriver                       |
| <input type="checkbox"/> Campstove                                     | <input type="checkbox"/> Nails & screws                    |
| <input type="checkbox"/> Dehydrated food (2 boxes of 4 dozen packages) | <input type="checkbox"/> Duct tape                         |
| <input type="checkbox"/> Scissors                                      | <input type="checkbox"/> Collection bags                   |
|  | <input type="checkbox"/> Shovel                            |

# STUDENT WORKSHEET

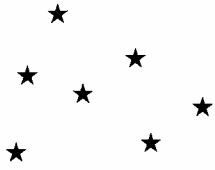

- |  |   |
|--|---|
| <input type="checkbox"/> Garbage bags              | <input type="checkbox"/> Pen  |
| <input type="checkbox"/> Canteens                  | <input type="checkbox"/> Pocket knife                               |
| <input type="checkbox"/> Soap                      | <input type="checkbox"/> Thermal jackets                            |
| <input type="checkbox"/> Washcloth                 | <input type="checkbox"/> Compass                                    |
| <input type="checkbox"/> Batteries                 | <input type="checkbox"/> Thermal gloves                             |
| <input type="checkbox"/> Can opener                | <input type="checkbox"/> Map  |
| <input type="checkbox"/> Toothbrush and toothpaste | <input type="checkbox"/> Gun  |
| <input type="checkbox"/> Backpack (6)              | <input type="checkbox"/> Thermal hats                               |
| <input type="checkbox"/> Kerosene (1 gallon)       | <input type="checkbox"/> Ammunition                                 |
| <input type="checkbox"/> First aid kit             | <input type="checkbox"/> Tents (2 two-person tents, 10 pounds each) |
| <input type="checkbox"/> Wool blankets             | <input type="checkbox"/> Toilet paper (2 rolls)                     |
| <input type="checkbox"/> Sunglasses (6)            | <input type="checkbox"/> Jewelry                                    |
| <input type="checkbox"/> Chapstick                 | <input type="checkbox"/> Magnifying glass                           |
| <input type="checkbox"/> Sunscreen                 | <input type="checkbox"/> Paper plates                               |
| <input type="checkbox"/> Cassette tapes            | <input type="checkbox"/> Napkins                                    |
| <input type="checkbox"/> Pocket video games        | <input type="checkbox"/> Cooler                                     |
| <input type="checkbox"/> Journal                   | <input type="checkbox"/> Soft drinks (1 case)                       |

## Reflection & Discussion

3. What items will you leave behind?
4. What items don't belong in the survival kit, but you would be willing to carry on a five-day walk to the base camp?
5. Compare and contrast surviving in a hostile environment like Antarctica to surviving in other places on Earth or in the Solar System, such as the Moon, Mars, a space station, or on an extended mission (two year, roundtrip) to Mars.
6. What was difficult about reaching a consensus? What would make it easier next time?
7. Using a Venn diagram, compare and contrast survival in Antarctica to surviving on the Moon, Mars, or a long-duration space mission.





# Glossary

**Acid**—In chemistry, a substance that may have a sour taste, makes blue litmus paper turn red, and can react with a base to make a salt.

**Ammeter**—A device used to measure electrical current, which is measured in amperes (A, or amps).

**Axis**—An imaginary line through the center of a planet or satellite around which it rotates.

**Base**—A substance that may have a bitter taste, feels soapy, and neutralizes acids.

**Blood Pressure**—The pressure of blood on the walls of blood vessels.

**Chromatography**—A method of separating a mixture of compounds by the use of a porous material.

**Compound**—A substance made by combining two or more parts or elements; water is a chemical compound made from hydrogen and oxygen.

**Coordinate System**—A grid system used to identify location. Latitude and longitude is an example of a coordinate system.

**Dehydrated**—The state a substance is in when moisture has been removed from it; too much heat can dehydrate the body.

**Diastolic**—A measurement of the amount of pressure on the walls of blood vessels when the heart is not contracting.

**Diffraction**—The bending of light as it passes through a small slit or opening; When we study the diffraction of sunlight, we see a rainbow of colors.

**Latitude**—The angular distance north or south of the Earth's equator. Latitude is measured in degrees.

**Longitude**—The angular distance east or west of the Prime Meridian (running through Greenwich, England). Longitude is expressed in degrees or units of time.

**Meteorite**—A small rocky or metallic object that has passed through the Earth's atmosphere and landed intact on its surface. Meteorites are fragments of larger objects such as comets, asteroids, or planets.

**Parallel**—Two lines running side by side at an equal distance apart. Railroad tracks run parallel to each other. Lines of constant latitude run parallel to the equator.



**pH**-A scale from 1-14 that specifies how acidic or base a substance is.

**Pigment**-The coloring of a particular object or substance (ex: the ink contained a blue pigment).

**Prism**-A transparent solid, usually with triangular bases and rectangular sides, that separates the colors of sunlight into a rainbow or spectrum.

**Propulsion**-The act of moving an object and maintaining its motion.

**Pulse rate**-The number of times a person's heart beats per minute.

**Respiration rate**-The number of breaths a person takes per minute.

**Spectroscope**-A device used for separating light into component colors for analysis.

**Sphygmomanometer**-A device used in conjunction with a stethoscope to measure a person's blood pressure.

**Stethoscope**-A device used to listen to internal functions of the body, such as breathing or heart beat.

**Systolic**-A measurement of the amount of pressure on the walls of the blood vessels when the heart is beating.

**Transceiver**-A radio that uses many of the same components for transmitting and receiving signals.

# Challenger Center Resources

**Challenger Center for Space Science Education:** Mixing a little adventure with education has proven to be a recipe for success, resulting in a vibrant, growing portfolio of Learning EdVentures programs. Classroom programs include *Vista Station* (grades 3-4); *Cosmic EdVentures: Exploring Earth's Neighborhood* (grades 3-6); *Mars City Alpha* (grades 5-8); and *Marsville: A Cosmic Village* (grades 5-8). *EdVentures in Simulation: A Great START to the 21st Century* is a professional development workshop sharing the secrets behind Challenger Center's simulations based on more than 10 years of experience conducting successful simulation programs. The Challenger Learning Center network reaches more than a quarter million students and teachers each year with full immersion simulations at its 42 sites across North America and in England. For more information contact your local Challenger Learning Center or write Challenger Center for Space Science Education, 1250 North Pitt Street, Alexandria, VA, 22314. Call (703) 683-9740.

## ALABAMA

**Challenger Learning Center at McWane Center**  
200 - 19th Street, North  
Birmingham, AL 35203  
205/714-8343; FAX 205/714-8400

## ALASKA

**Challenger Learning Center of Alaska**  
9711 Kenai Spur Highway  
Kenai, AK 99611  
907/283-2000; FAX 907/283-2279

## ARIZONA

**Challenger Learning Center of Arizona**  
21170 North 83rd Avenue  
Peoria, AZ 85382  
623/322-2001; FAX 623/322-3716

## Challenger Learning Center of the Southwest

Pima Air and Space Museum  
6000 East Valencia  
Tucson, AZ 85706  
520/574-0462; FAX 520/618-4872

## CALIFORNIA

**Castle Challenger Learning Center of the San Joaquin Valley**  
Castle Challenger Learning Center Foundation  
Castle Airport Aviation and Development Center  
3460 Challenger Way  
Atwater, CA 95301  
209/726-0296; FAX 209/726-3491

## Honeywell Challenger Learning Center

at CSU, Dominguez Hills  
1000 East Victoria Street  
SAC III Building, Room 3165  
Carson, CA 90747  
310/243-2627; FAX 310/516-3371

## Challenger Learning Center at Chabot Space & Science Center

10000 Skyline Blvd.  
Oakland, CA 94619  
510/336-7355; FAX 510/336-7491

## Nierman Challenger Learning Center

Reuben H. Fleet Science Center  
P.O. Box 33303  
San Diego, CA 92163  
619/238-1233; FAX 619/685-5771

## Challenger Learning Center

Discovery Museum Science Center  
3615 Auburn Blvd.  
Sacramento, CA 95821  
916/575-3941; FAX 916/575-3925

## CONNECTICUT

### Challenger Learning Center at

### Discovery Museum, Inc.

4450 Park Avenue  
Bridgeport, CT 06604  
203/372-3521; FAX 203/374-1929

## DISTRICT OF COLUMBIA

### Challenger Learning Center of Greater Washington

1250 North Pitt Street  
Alexandria, VA 22314  
703/837-6540; FAX 703/535-1372

## ENGLAND

### National Space Science Centre

### Challenger Learning Centre

Exploration Drive (Off Corporation Road)  
Leicester, LE45NS  
UK  
(0)11-44-116-258-2132 (ext. 351);  
FAX (0)11-44-116-258-2100

FLORIDA  
**Challenger Learning Center at Kirby Smith  
Middle School**  
2034 Hubbard Street  
Jacksonville, FL 32206-3798  
904/630-6601; FAX 904/630-6996

**Verizon Challenger Learning Center  
Museum of Science & Industry**  
4801 East Fowler Avenue  
Tampa, FL 33617  
813/987-6300; FAX 813/987-6364

GEORGIA  
**Challenger Learning Center  
Coca-Cola Space Science Center**  
701 Front Avenue  
Columbus, GA 31901  
706/649-1470; FAX 706/649-1478

HAWAII  
**Challenger Center Hawaii**  
Barbers Point Elementary School  
3001 Boxer Road  
Kapolei, HI 96707-2103  
808/673-7410; FAX 808/682-3924

ILLINOIS  
**Challenger Learning Center for Science &  
Technology**  
222 Church Street  
Woodstock, IL 60098  
815/338-7722

INDIANA  
**Brownsburg Challenger Learning Center**  
725 South Green Street  
Brownsburg, IN 46112  
317/852-1008; FAX 317/858-4102

**Challenger Learning Center of Northwest Indiana  
Perdue University Calumet**  
2300 173<sup>rd</sup> Street  
Hammond, IN 46323  
219/989-3255; FAX 219/989-3256

IOWA  
**Science Center of Iowa**  
4500 Grand Avenue  
Des Moines, IA 50312  
515/274-4138; FAX 515/274-3404

KENTUCKY  
**Challenger Learning Center of Kentucky**  
Gorman Center  
601 Main Street  
Hazard, KY 41701  
606/439-5856 800/334-2793; FAX 606/435-1102

**Challenger Learning Center of Hardin County**  
c/o City of Radcliff  
411 West Lincoln Trail Blvd.  
Radcliff, KY 40160  
270/351-7827; FAX 270/352-0354

LOUISIANA  
**Louisiana Arts & Science Center**  
P.O. Box 3373  
Baton Rouge, LA 70821-3373  
225/344-5272 (ext. 4); FAX 225/344-9477

MARYLAND  
**Howard B. Owens Science Center**  
9601 Greenbelt Road  
Lanham, MD 20706  
301/918-8750; FAX 301/918-8753

MASSACHUSETTS  
**Christa Corrigan McAuliffe Challenger Center  
Framingham State College**  
100 State Street  
Framingham, MA 01701  
508/626-4050; FAX 508/626-4059

MICHIGAN  
**Kalamazoo Valley Museum**  
P.O. Box 4070  
Kalamazoo, MI 49003-4070  
616/373-7990; FAX 616/373-7997

MISSOURI  
**Challenger Learning Center  
Science City at Union Station**  
30 West Pershing Road  
Kansas City, MO 64108-2422  
816/460-2000; FAX 816/460-2260

NEW JERSEY  
**Buehler Challenger & Science Center**  
305 Route Seventeen South  
Paramus, NJ 07652  
201/251-8589; FAX 201/251-9049

NEW YORK  
**Challenger Learning Center of Greater  
Rochester**  
Rochester Museum & Science Center  
657 East Avenue  
Rochester, NY 14607  
716/473-7490 FAX 716/473-4388

**Challenger Learning Center of the Lower Hudson  
Valley**  
P.O. Box 158  
Suffern, NY 10901  
845/357-3416; FAX 845/369-3523

NORTH CAROLINA  
**Challenger Learning Center  
Discovery Place, Inc.**  
301 North Tryon Street  
Charlotte, NC 28202  
704/372-6261; FAX 704/337-2670

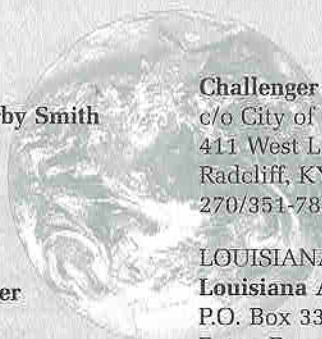

OHIO

**Challenger Learning Center of Dayton**

1401 Leo Street  
Dayton, OH 45404  
937/542-6143; FAX 937/542-6195

ONTARIO

**Ontario Science Centre**

770 Don Mills Road  
Toronto, Ontario  
Canada M3C 1T3  
416/429-4100; FAX 416/696-3197

SOUTH CAROLINA

**Challenger Learning Center**

**RSD1**

2600A Barhamville Road  
Columbia, SC 29204  
803/929-3951; FAX 803/929-3959

TENNESSEE

**Challenger Learning Center at University of Tennessee at Chattanooga**

615 McCallie Avenue  
Chattanooga, TN 37403-2598  
423/755-4126; FAX 423/785-2190

TEXAS

**Houston Museum of Natural Science**

One Hermann Circle Drive  
Houston, TX 77030  
713/639-4631; FAX 713/639-4635

**George Observatory**

Brazos Bend State Park  
21901 FM 762  
Needville, TX 77461  
979/553-3400; FAX 979/553-3331

**Challenger Learning Center of San Antonio**

P.O. Box 35400  
Brooks AFB, TX 78235  
210/534-8398; FAX 210/532-9920

**Challenger Learning Center of the Rio Grande Valley**

P.O. Box 343  
San Benito, TX 78586  
956/361-5551; FAX 956/361-8933

VIRGINIA

**Mathematics & Science Center**

2401 Hartman Street  
Richmond, VA 23223  
804/343-6525; FAX 804/343-6534

WASHINGTON

**Museum of Flight**

9404 East Marginal Way South  
Seattle, Washington 98108  
206/764-5700; FAX 206/764-5707

WEST VIRGINIA

**Challenger Learning Center at Wheeling Jesuit University**

316 Washington Avenue  
Wheeling, West Virginia 26003-6295  
304/243-4325; FAX 304/243-2086





# Acknowledgments

## **Mission Prep Development Crew**

Jason W. Smith, M.S. Curriculum & Instruction  
Lead Instructional Designer

Carla Rosenberg, Instructional Designer  
Matthew Bobrowsky, Ph.D., Astrophysicist  
Karen Offringa, M.Ed., Editor  
Program Innovations Team  
Space Science Research Team  
Learning EdVentures Team

## **Special Thanks**

Challenger Center For Space Science Education extends many thanks to the following education consultants for their contributions to this activity guide:

Donna Matthews, M.S. Space Studies  
Barbara Tolbert, Performance Based Instructional Specialist  
Renita Spriggs, M.Ed. Special Education  
Carlton Carter, M.Ed. Administration & Supervision

The Flight Directors of the Challenger Learning Center Network

Original Activities written by Sue S. Griswold, M.Ed.  
and Margaret H. Dickson

Challenger Center, Challenger Center For Space Science Education, and the Challenger Center logotype are registered trademarks of Challenger Center For Space Science Education.



CHALLENGER CENTER FOR SPACE SCIENCE EDUCATION



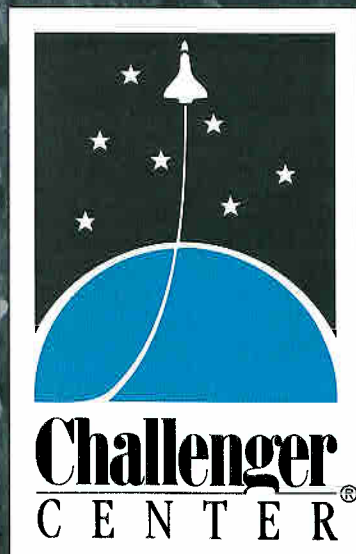

**The creation of these educational activities was made possible by support from NASA's Discovery Mission Program and the Jet Propulsion Laboratory's STARDUST Project.**